

## Operating Instructions

# Minebea Intec Signum<sup>®</sup> 1 | Signum<sup>®</sup> 2 | Signum<sup>®</sup> 3

Models SIWABBP | SIWSBBP | SIWSBBS | SIWRDCP | SIWADCP | SIWSDCP | SIWSDCS | SIWAEDG Complete Scales

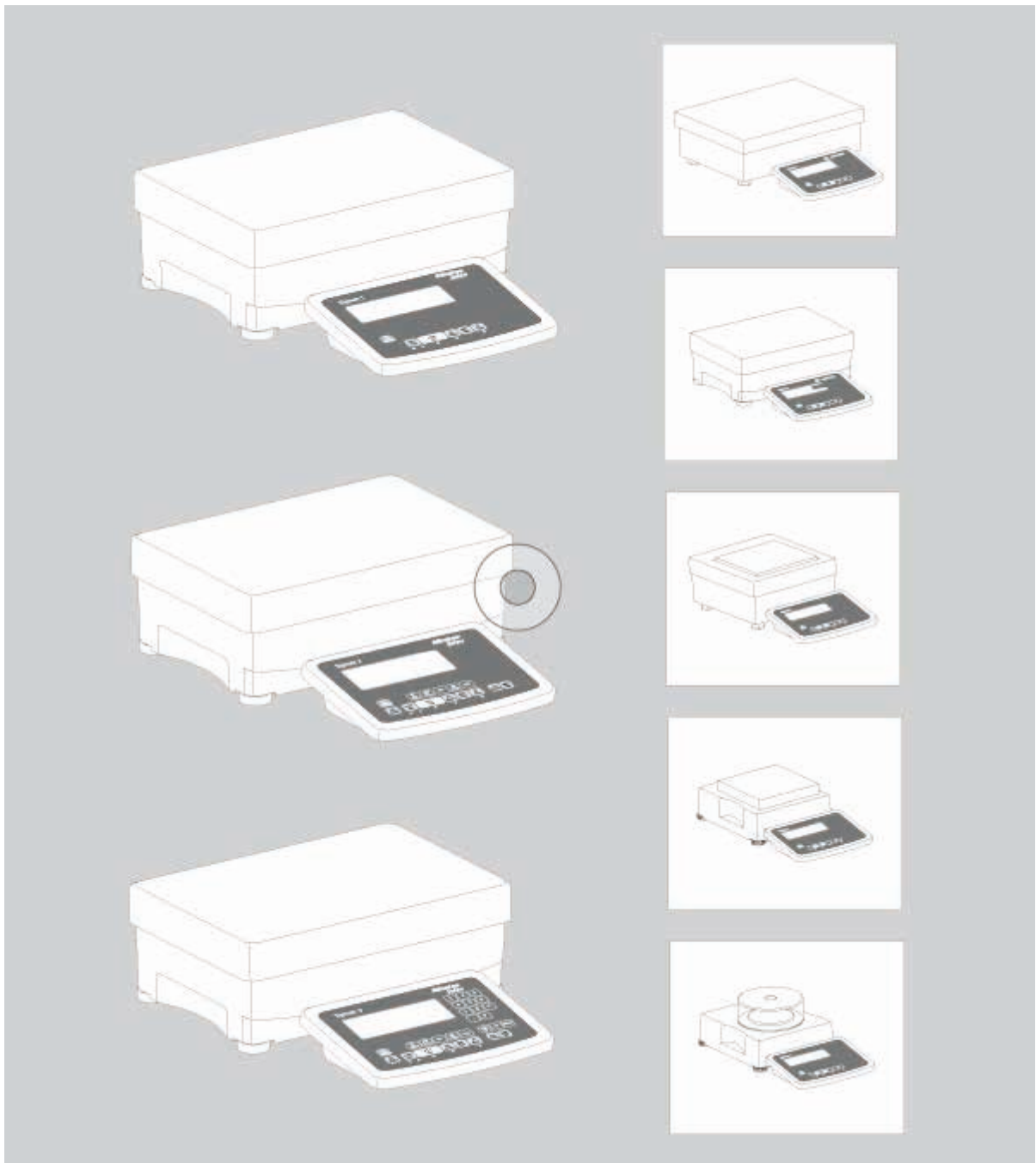

## Intended Use

Signum® 1, 2 and 3 are precise and rugged complete scales that give you reliable weighing results.

The Signum® series of compact scales includes models with strain-gauge weighing systems as well as versions equipped with monolithic technology, using the principle of electromagnetic force compensation.

These compact industrial scales offer the following special features:

- Rugged and durable Minebea Intec quality
- Flexible options for display unit installation
- Wide range of configuration options for customized operation
- Variety of optional data interfaces
- Optional IP65 protection from dust and jets of water (standard for the SIWSDCS/SIWSBBS/SIWAEDG series)
- Optional versions for use in zone 2 and 22 hazardous areas
- High quality workmanship and materials
- Choice of application levels
- Available in weighing capacities between 3 and 35 or 60 kg; choice of resolutions available for each capacity
- Various interface options
- Verifiable models in accuracy classes  $\text{II}$  (SIWS...) and class  $\text{III}$  (SIWR)
- Option for use in hazardous areas zones 2, 22
- Preload values can be defined (for equipment installed on the scale)
- Display can be decoupled from the weighing technology

Additional features include:

- Large keys with positive click action
- Numeric and alphabetic input
- Large backlit 14-segment display
- Connectivity for two weighing platforms (digital platform or, using an optional A/D converter, analog platform)

Advantages in routine weighing tasks:

- Fast response times
- Independence from location of platform installation
- Designation of weight values with up to 4 lines of alphanumeric text
- Flexibility afforded by diversity of interfaces
- Security through password protection

## Range of Models

Three different type of weighing technology are used in the Signum® series, offering different performance levels:

### Signum® Regular

#### SIWRDCP Models

- Standard weighing system
- Resolutions up to 35,000d.
- Models verified at the factory for use in legal metrology, Class  $\text{III}$ :  
2 x 3000/3500e (dual range);  
1 x 6000/7500e and  
1 x 3000e (single range)
- The single-range scales with variable scale intervals are available with your choice of a fixed or adjustable fine range

### Signum® Advanced

#### SIWADCP/SIWAEDG models:

- Mechatronic weighing system
- Resolutions up to 80,000d

#### SIWABBP models:

- Mechatronic weighing system
- Resolutions up to 150,000d.

### Signum® Supreme

#### SIWSDCP models:

- Monolithic Weighing System
- Resolutions up to 350,000d.

#### SIWSBBP models:

- Monolithic Weighing System
- Resolutions up to 620,000d.

- Models verified at the factory for use in legal metrology, Class  $\text{II}$ :  
130,000e, 1x62,000e (e=d);  
1x6000e, 31,000e,  
35,000e, 61,000e  
(single and dual range);  
16,000e (single and dual range) each with internal motorized calibration weight

- The single-range scales with variable scale intervals are available with your choice of a fixed or adjustable fine range

## Signum® Supreme featuring a stainless steel housing

#### SIWSDCS/SIWSBBS models:

- Monolithic Weighing System
- Resolutions up to 610,000d
- Models verified at the factory for use in legal metrology, Class  $\text{II}$ :  
1 x 30,000e (e=d); 1 x 6000e;  
35,000e (single and dual range);  
16,000e (single and dual range,  
each with internal motorized  
calibration weight)
- The single-range scales with variable scale intervals are available with your choice of a fixed or adjustable fine range

Signum® Regular/Advanced/Supreme are all available with application levels 1, 2 and 3.

## Symbols

The following symbols are used in the text:

- Denotes general operating instructions
- Indicates instructions for exceptional cases
- > Describes the outcome of an operating step
- △ Indicates a hazard

#### Hotline

Phone: +49.40.67960444

Fax: +49.40.67960474

# Content

<b>Intended Use</b> .....	2	<b>Configuration</b> .....	16	<b>Configuring Printouts</b> .....	81
<b>Contents</b> .....	3	Setting the Language .....	16	<b>Configuring the Product</b>	
<b>Warnings and Safety Precautions</b> .....	4	Configuring a Password .....	17	<b>Data Memory</b> .....	83
<b>Getting Started</b> .....	5	Operating Menu Overview.....	18	<b>Interface Port</b> .....	84
Unpacking the Scale .....	5	<b>Operation</b> .....	39	Connector for a Second Weighing	
Equipment Supplied .....	5	Basic Weighing Function.....	39	Platform.....	85
Installation.....	5	Weighing $\bar{\Delta}\bar{\Delta}$ .....	39	Pin Assignment Chart .....	85
Conditioning the Scale .....	5	Device Parameters.....	39	Pin Assignments for COM1 .....	85
Checking the Geographical Data		Tare Function in Weighing.....	39	Pin Assignments for UniCOM.....	85
for Use in Legal Metrology.....	5	Numeric input for Weighing .....	41	Wiring Diagram	
Under-Scale Weighing .....	5	Weighing with Variable Tare Values.....	42	(Indicator <-> PC).....	86
Installing the Display and Control Unit..	6	Calibration and Adjustment .....	43	Configuring the Data Interface	
Connecting the Device to AC Power .....	8	SQmin Function .....	47	as a COM Port .....	87
Leveling the Weighing Platform .....	8	Data ID Codes.....	49	Data Input Format (Command) .....	87
<b>General View of the Equipment</b> .....	9	Combining Application Programs.....	51	Data Output Format .....	88
Display and Keypad.....	9	Counting.....	52	Configuring the Data Interface	
Back Panel .....	9	Neutral Measurement .....	56	as a Printer Port .....	89
<b>Operating Design</b> .....	10	Averaging.....	59	Automatic Data Output (SBI).....	90
Keypad .....	10	Weighing in Percent .....	62	GMP-compliant Printouts .....	91
Keypad Input.....	10	Checkweighing .....	65	<b>Error Codes</b> .....	92
Input Through the Digital Control Port..	11	Checkweighing Toward Zero.....	68	<b>Care and Maintenance</b> .....	93
Input Using a Barcode Scanner or		Classification .....	69	<b>Recycling</b> .....	93
External Keyboard.....	11	Totalizing.....	72	<b>Overview</b> .....	94
Display Modes .....	12	Net-total Formulation .....	75	Common Specifications.....	94
Measuring Range Display .....	13	Examples of Application Combinations		Signum® Model Designator .....	94
Saving Data in Weighing Mode .....	14	in Signum® 3.....	79	Model-specific Specifications.....	95
Operating Menu Navigation.....	14			Dimensions (Scale Drawings) .....	99
Error Codes.....	15			Accessories.....	102
Data Output.....	15			Declaration of Conformity.....	105
Saving Data .....	15			EC Type Approval Certificate .....	109
				Plates and Markings.....	110
				Index .....	120
				<b>Appendix</b>	
				General Password.....	121

## Warning and Safety Instructions

Signum scales comply with the European Council Directives as well as international regulations and standards for electrical equipment, electromagnetic compatibility, and the stipulated safety requirements.

- Read these operating instructions thoroughly before using your device. That way you will prevent damage to the equipment.
- ⚠ Do not use this equipment in hazardous areas without option Y2.
- ⚠ The indicator may only be opened by authorized service technicians who have been trained by Minebea Intec and who follow Minebea Intec' standard operating procedures for maintenance and repair work.
- ⚠ Make absolutely sure to unplug the indicator from power before you connect or disconnect any electronic peripheral devices to or from the interface port.
- ⚠ If you use electrical equipment in installations and under ambient conditions requiring higher safety standards, you must comply with the provisions as specified in the applicable regulations for installation in your country.
- ⚠ The display value can be affected by extreme electromagnetic influences. Once the disturbance has ceased, the instrument can be used again in accordance with its intended purpose.
- Warning when using pre-wired RS-232 connecting cables: RS-232 cables purchased from other manufacturers often have pin assignments that are incompatible with Minebea Intec products. Be sure to check the pin assignments against the chart in this manual before connecting the cable, and disconnect any lines identified differently from those specified by Minebea Intec.
- Use only extension cords that meet the applicable standards and have a protective grounding conductor.
- Disconnecting the ground conductor is prohibited.
- Note on Installation:  
The operator shall be responsible for any modifications to the equipment and for any connections of cables or equipment not supplied by Minebea Intec and must check and, if necessary, correct these modifications and connections.  
Information on operational quality is available on request from Minebea Intec (in line with norms pertaining to immunity).
- If there is visible damage to the equipment or power cord: unplug the equipment and lock it in a secure place to ensure that it cannot be used for the time being.

### IP Rating

- All models are rated to IP43
- Only connect Minebea Intec accessories and options, as these are optimally designed for use with your Signum scale.
- Do not unnecessarily expose the device to aggressive chemical vapors or to extreme temperatures, moisture, shocks, or vibration.
- Only clean the device as stipulated in the cleaning instructions: see “Care and Maintenance.”
- If you have any problems with your Signum scale: contact your local Minebea Intec office, dealer or service center.

### IP Protection:

- The protection rating for the display and control unit is ensured only if the rubber gasket is installed and all connections are fastened securely (including the caps on unused sockets). Weighing platforms and equipment must be installed and tested by a certified technician.
- If you install an interface port or battery connector after setting up your Signum, keep the protective cap(s) in a safe place to be used for protecting the interface port or battery connector when not in use, or prior to shipment. Do not leave the interface port uncovered. If you are not using a particular connector, replace the cap to protect the data interface from vapors, moisture and dust or dirt.

### Using the Equipment in Legal Metrology:

- If the scale is to be verified, make sure to observe the applicable regulations regarding verification.
- If any of the verification seals are damaged, make sure to observe the national regulations and standards applicable in your country in such cases. In some countries, the equipment must be re-verified.

## Getting Started

### Unpacking the Equipment

- After unpacking the equipment, please check it immediately for any external damage.
- If you detect any damage, proceed as directed in the chapter entitled “Care and Maintenance” under “Safety inspection.”
- Save the box and all parts of the packaging for any future transport. Unplug all connected cables before packing the equipment.

### Equipment Supplied

- Complete scale
- Operating instructions
- Special accessories as listed on the bill of delivery, if ordered

### Setup

Choose a location that is not subject to the following negative influences:

- Heat (heater or direct sunlight)
- Drafts from open windows and doors
- Extreme vibrations during weighing
- Excessive moisture

### Acclimatization

Moisture in the air can condense on cold surfaces whenever the equipment is moved to a substantially warmer place. To avoid the effects of condensation, condition the scale for about two hours at room temperature, leaving it unplugged from the power supply.

### Equipment Downtime

Switch off the equipment when not in use.

### Checking the Geographical Data Entered for Use in Legal Metrology (SIWR Models Only):

#### Preparation

(See also the “Device Information” menu items listed under “Operating Menu Overview” in the chapter entitled “Configuration”)

- Press the  $\text{I/O}$  key to turn on the scale
- While all segments are lit, press the  $\text{T}$  key
- > *APPL* is displayed
- To select “Device-specific information,” press  $\text{Fn}$  repeatedly; press  $\text{T}$  to confirm
- To switch the display between information on weighing platform 1 and weighing platform 2, press  $\text{Fn}$  repeatedly; press  $\text{T}$  to confirm
- > View geographical data (configured prior to verification), for example:  
Latitude (in degrees):  $51^{\circ}4'$   
Altitude (in meters):  $513^{\text{m}}$   
or  
Gravitational acceleration (in  $\text{m/s}^2$ ):  $9.810^{\text{m/s}^2}$

The scale can be used in legal metrology anywhere in Germany if the geographical data is as follows:

- Latitude: 51.00 degrees
  - Altitude: 513 m
- This data corresponds to the following value:
- Grav. acc.:  $9.810 \text{ m/s}^2$

These values are calculated for Germany based on a mean value for the Earth’s acceleration. The greater the precision of the geographical data entered, the greater the precision achieved with the weighing instrument; the tolerance range, however, is restricted accordingly (see above).

The tolerance ranges, for example for a scale with 3000e, are as follows:

- $\pm 100 \text{ km}$  for the latitude, and
- $\pm 200 \text{ m}$  for the elevation above seal level

- △ If used outside the specified zone, the scale must be re-verified for use in legal metrology: Please contact an authorized service technician.

### Under-Scale Weighing SIW\_BBP

A port for a under-scale weighing hook is located on the bottom of the weighing platform.

- Remove the cover plate from the scale base (<-).
- Screw in the under-scale weighing hook accessory.
- Hang the sample from the hook (e.g. using a bent wire). (Install a draft shield if necessary).

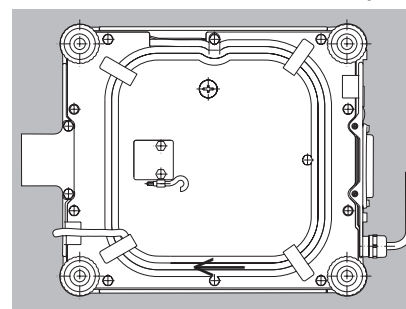

### Under-Scale Weighing SIW\_DCP

A port for a under-scale weighing hook is located on the bottom of the weighing platform.

- Remove the cover plate from the scale base (<-).
- Screw in the under-scale weighing hook accessory.
- Hang the sample from the hook (e.g. using a bent wire). (Install a draft shield if necessary).

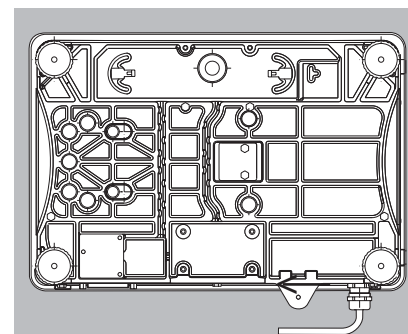

- △ Under-scale weighing cannot be used with the SIWR... and SIWABBP. Signum under-scale weighing hooks can be ordered using option U1.

## Getting Started

### Installing the Display and Control Unit

The following options are available for installing the control unit: (the pictures depict the SIW\*DCP model)

- Fastening the display and control unit to the weighing platform:
- Guide the display and control unit onto the retainer bracket.
- Level the weighing platform (see page 7).

- Attached to the weighing platform
- On the YDH01P column: optional for the DCP model
- On the YDH02P column: optional for the BBP model
- On the YDH0xCWS column: optional for the DCS model
- On the YDH02CWP column: optional for the EDG model

Operating the display and control unit separately:

- Turn the weighing platform over and place it on a soft surface to avoid damaging the weighing system.
- Remove the display and control unit retainer bracket.
- Take the cable out of the cable channel.
- Turn the weighing platform right side up and place it so that it rests on its feet.
- Level the weighing platform (see page 7).

Installing the display and control unit on the YDH01P column:

- Turn the weighing platform over and place it on a soft surface to avoid damaging the weighing system.
- Remove the display and control unit retainer bracket.
- Take the cable out of the cable channel.

- Use the four hexagonal screws provided (M4x8) to attach the column to the weighing platform (back panel facing downward).
- Turn the weighing platform right side up and place it so that it rests on its feet.

- Loosen the two locking bolts at the top of the column to facilitate installation of the display and control unit.
- Use the three hexagonal screws (M4x8) to attach the display and control unit to the top of the column.
- Adjust the display and control unit to the desired angle and secure it there.
  - This is done by tightening the locking bolts on the top of the column.

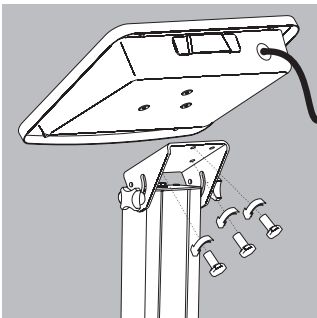
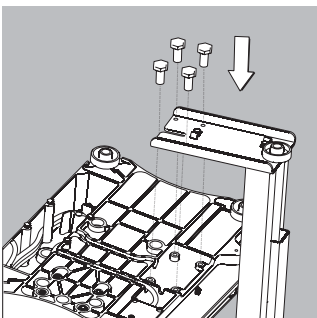
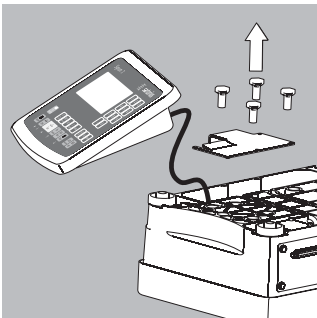
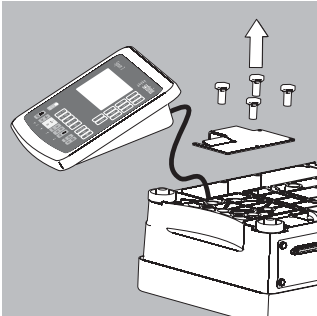
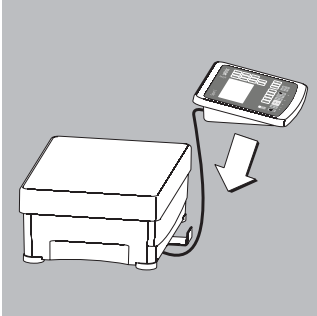

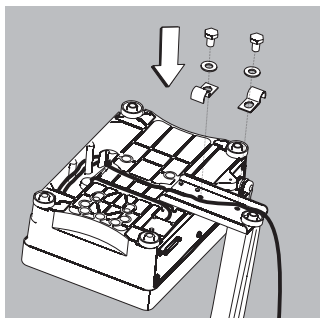

- A recessed space is provided in the scale base, accessed from the bottom of the scale, for any excess length of cable.
- Guide the connecting cable along the channel on the bottom of the weighing platform.
- Use the cable clamps provided to affix the cable that connects the display and control unit to the weighing platform to the bottom of the column.
- Turn the weighing platform right side up and place it so that it rests on its feet.

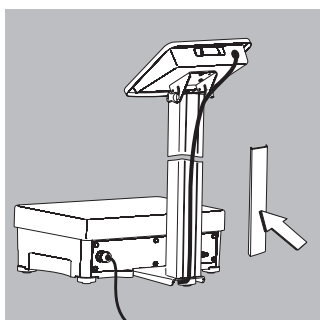

- Attach the cable retainer to affix the cable connecting the display and control unit to the weighing platform to the back of the column.

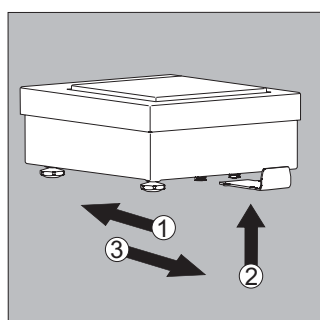

#### SIWSBBS Installing the Display and Control Unit:

- 1 Slide the bracket under the weighing platform.
- 2 Press up into the openings.
- 3 Pull the bracket forward to lock into place.

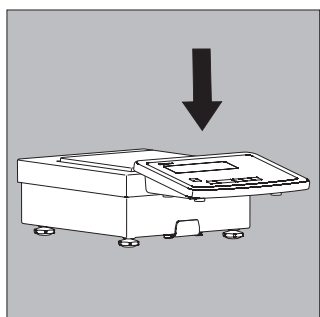

- Hang the display and control unit on the bracket.

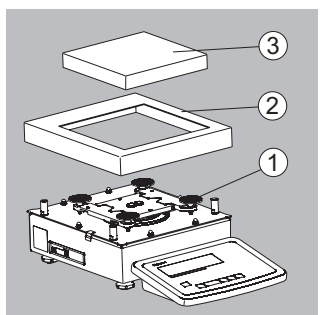



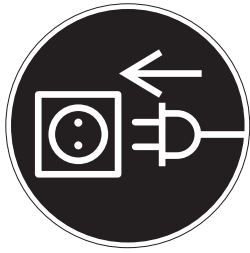

**Connecting the Device to AC Power**

- Check the voltage rating and plug design
- The equipment is powered through the installed power cord.  
The power supply is integrated into the indicator. The device can be operated with a voltage of 100 V to 240 V.  
Make sure that the voltage rating printed on the manufacturer's ID label is identical to that of your local line voltage. If the voltage specified on the label or the plug design of the AC adapter do not match the rating or standard you use, please contact your Minebea Intec office or dealer. The power connection must be made in accordance with the regulations applicable in your country.

In order to connect the equipment to the power supply (protection class 1), use a correctly installed wall outlet with a protective grounding conductor (PE) and a fuse of a maximum 16 A. The power plug or a different, suitable disconnecting device for the power must be easily accessible.

**Safety Precautions**

If you use an electrical outlet that does not have a protective grounding conductor, ensure that an equivalent protective conductor is installed by a certified electrician (as specified in the applicable regulations for installation in your country). The protective effect must not be negated by using an extension cord without a protective grounding conductor.

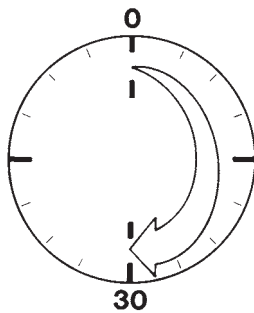

**Warm-up Time**

To return precise results, the scale must warm up for at least 30 minutes after initial connection to the power supply. Only after this time will the scale have reached the required operating temperature.

- Using a verified scale in legal metrology:
- Ensure that there is a warm-up time of at least 24 hours after initial connection to the power supply.

**Connecting a Barcode Scanner (Accessory; Order No. YBR02FC)**

- △ Disconnect the indicator from AC power (unplug the AC adapter)
- Installation:  
please see "Pin Assignment Charts" in this manual  
(implemented via the YCC02-BR02 connecting cable or as Option M8)

**Leveling the Weighing Platform SIWABBP, SIWSBBP, SIWSBBS, SIWRDCP, SIWADCP, SIWSDCP, SIWSDCS**

Purpose:

- To compensate for uneven areas at the place of installation
  - To ensure that the equipment is placed in a perfectly horizontal position for consistently reproducible weighing results
- Always level the weighing platform again any time after it has been moved to a different location.

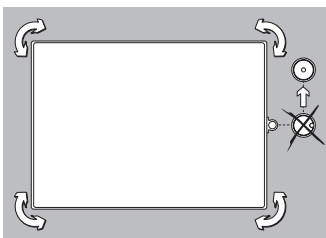

- Level the weighing platform using the four leveling feet. Turn the feet until the air bubble is centered in the level indicator.
- Check to ensure that all leveling feet rest securely on the work surface.
- > Each of the leveling feet must support an equal load.

**Level the Weighing Platform SIWAEDG**

- Use an open-jawed wrench to loosen the lock nuts on the leveling feet.
- > Adjusting the leveling feet:  
To raise the weighing platform, extend the leveling feet (turn counterclockwise).  
To lower the weighing platform, retract the leveling feet (turn clockwise).
- Tighten the lock nuts after adjusting the weighing platform.

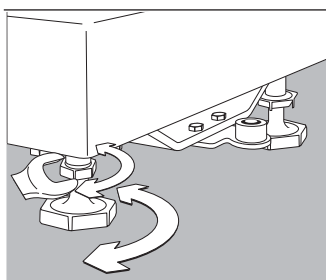



# General View of the Equipment

Signum® 1

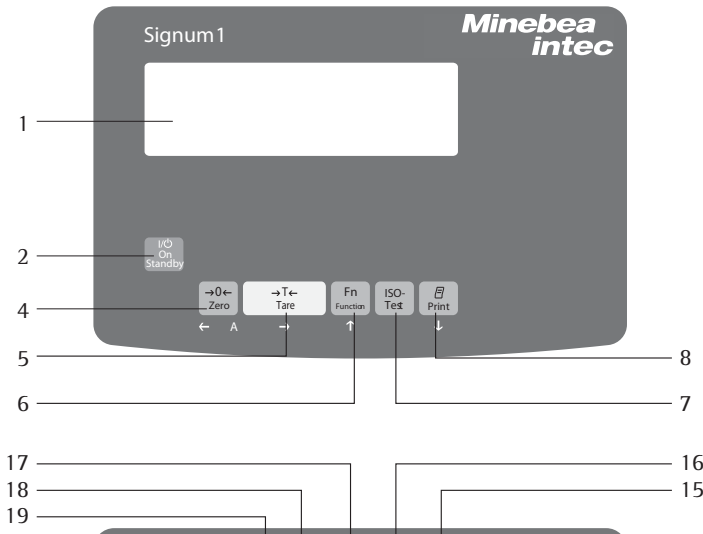

Signum® 2

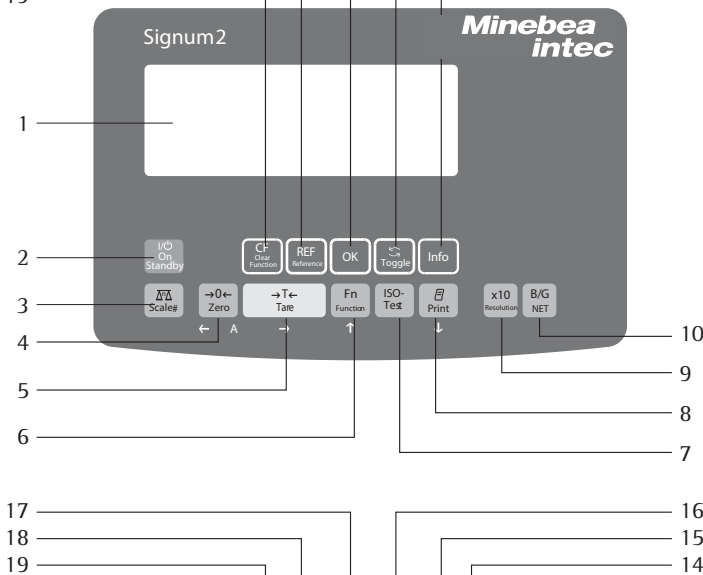

Signum® 3

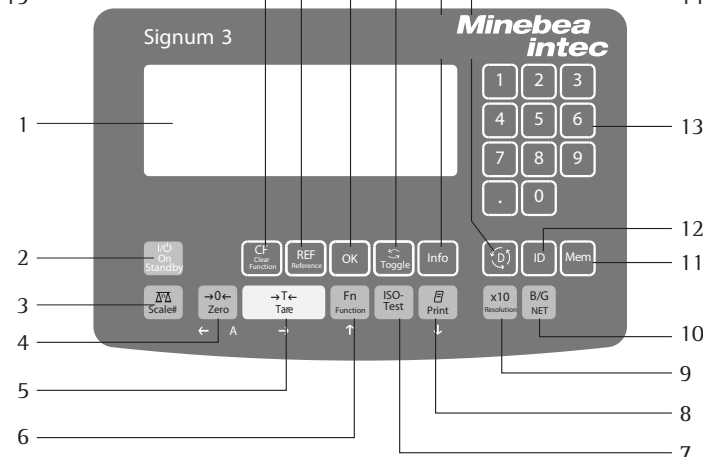

## Display and Keypad

- 1 Display  
(for details, see the chapter entitled "Operating Design")
- 2 On/Off key (Standby)
- 3 Toggle key  
(toggle display between weighing platforms)
- 4 Zero key
- 5 Tare key
- 6 Function key (toggle between gross/net values)
- 7 Start calibration or adjustment
- 8 Print key (data output)
- 9 Toggle unit between normal and 10-fold higher resolution
- 10 View gross value (net value plus tare)  
View net value (gross value minus tare)
- 11 Save key
- 12 ID key (for entering operator ID)
- 13 Alphanumeric keypad
- 14 Toggle between application program and application-specific information
- 15 Display of applications and manual tare values
- 16 Toggle key  
(function depends on application)
- 17 OK key  
(function depends on application)
- 18 Reference value key  
(function depends on application)
- 19 Clear function key  
(function depends on active application)

## Back panel

- 20 RS232C interface (COM1)  
(standard equipment)
- 21 Power cord connection
- 22 RS232C interface (COM1)  
(standard equipment)
- 23 Weighing platform connection

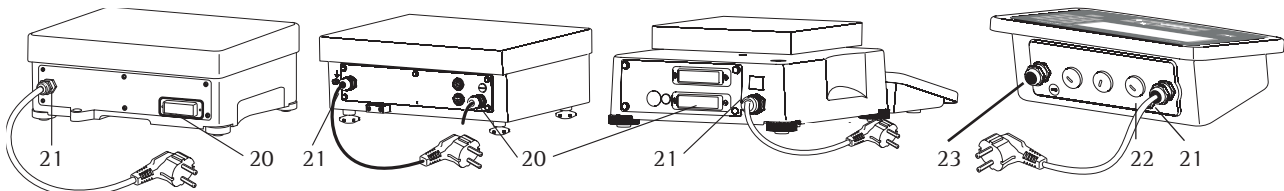

## Operating Concept

### Keypad

Operating the Signum® 1, Signum® 2 and Signum® 3 involves just a few keys. These keys have one function during measurement and another during configuration. Some of the keys have one function when pressed briefly, and another when pressed and held for longer than 2 seconds.

If a key is inactive, this is indicated as follows when it is pressed:

- The message "-----" is displayed for 2 seconds. The display then returns to the previous screen content

You can use Signum® 2 and 3 to collect weight values from two weighing platforms, calculate and display weight values using application programs, and assign IDs to the samples weighed.

Configure the display and control unit first, using the operating menu to setup the desired application program (printer settings, etc.). Then you can begin weighing.

## Input







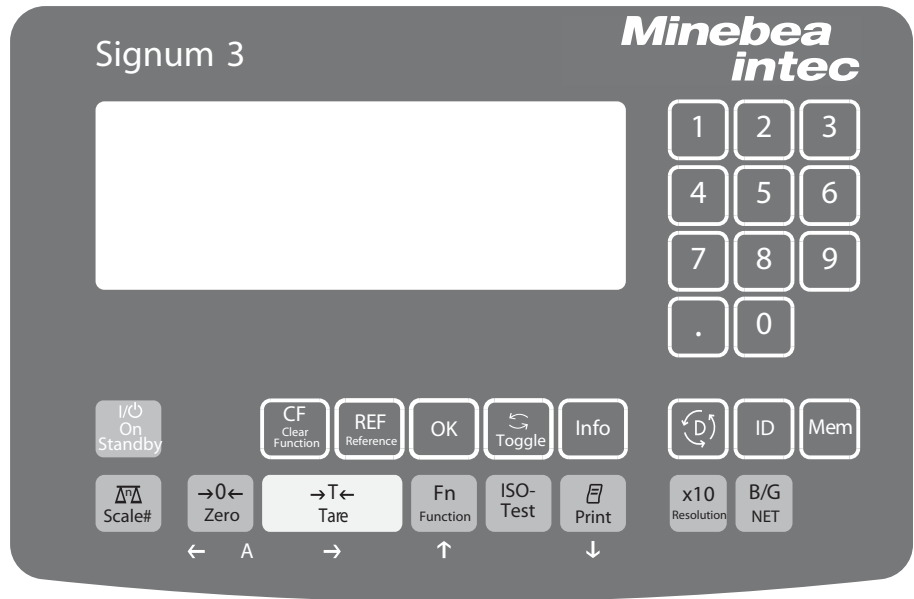











### Keypad Input

#### Labeled Keys

Some keys have a second function, activated by pressing and holding the key for over 2 seconds. Whether a function is available depends on the indicator operating state and operating menu settings.



Signum® 3 operating panel

-  **On/Off**  
(in Standby mode, *STANDBY* is displayed).
-  **CF** Signum® 2 and 3 only  
If a second weighing platform is connected, this key toggles the display between the two readouts.
-  **REF** - Zero the scale  
- Cancel calibration/adjustment
-  **OK** - Tare the scale
-  **Fn** Toggles between the 1st and 2nd weight unit, or gross and net values, or normal and 10-fold higher resolution, depending on operating menu settings (depends on model)
-  **ISO-Test** Start calibration or adjustment
-  **Print** - To print: press briefly  
- To print GMP footer: Press and hold (> 2 seconds)
-  **Toggle** Signum® 3 only  
Toggles to available application
-  **ID** Signum® 3 only  
ID key (for entering operator ID)
-  **x10** Signum® 2 and 3 only  
Toggles unit between normal and 10-fold higher resolution
-  **B/G** Signum® 2 and 3 only  
Net-gross value key
-  **Info** Signum® 2 and 3 only  
Toggles between display modes within an application program
-  **REF** Signum® 2 and 3 only  
Lets you modify reference values
-  **OK** Signum® 2 and 3 only  
Saves a value or starts an application program
-  **Mem** Signum® 3 only  
Saves a value to the product data memory
-  **CF** Delete key: Deletes initialization values or totalizing memory. During numeric entry the last character entered is deleted.
-  **Info** Info key: Used to display application parameters and manual tare values (Info after pressing a follow-up key, e. g. )

Signum® 2 and 3 only

- Info** Displays applications and manual tare values:

Immediately closes information display: **Info** press and hold longer than 2 seconds. The information is displayed in succession.

Signum® 2 and 3 only

- CF** - Quits an application or deletes and input character

Signum® 3 only

**0**, **1**, **2**... **9**, **.**

Enters numbers, letters and other characters

### Numeric Input via the Keypad (Signum® 3 only)

- To enter numbers (one digit at a time): Press **0**, **1**, **2**... **9**
- To save input: press the corresponding key. For example, press **↔T←** to save manual tare input.
- To delete a digit: Press **CF**

### Loading a Tare Value from the Weighing Platform

To save the weight on the weighing platform as a tare weight: Press the **↔T←** key

### Input Through the Digital Control Port

You can connect a remote hand switch or foot switch to the input control line, for use with all application programs. Assign one of the following functions to this switch in the Setup menu, under Device parameters - Control input (*CTRL IO*):

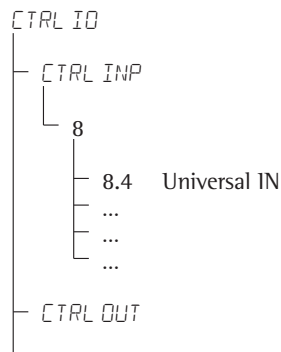

For a detailed list of menu items, please see the chapter entitled "Configuration."

### Input Through the ASCII Port

See page 85, "Data Input Format."

### Input Using a Barcode Scanner or External Keyboard

Input via a barcode scanner or keyboard is handled in the same manner as keypad input:

- Weight values for the tare memory
- Reference weight values for the Counting, Neutral Measurement and Weighing in Percent applications
- Numerical values
- Product identifiers

Signum® 2 and 3 only

Barcode scanner input can trigger a function or load information for display on the display and control unit. You can configure this option in the Setup menu via:

*BARCODE*

- 1) Can be saved directly for:
  - REF
  - TARE
  - IDI
- 2) INPUT: Read the barcode and then press the respective key
- 3) HEADER: The assignment of the 1st value is coded in the barcode:
  - REF
  - TARE
  - IDI-4

Coding available upon request.

## Display Modes

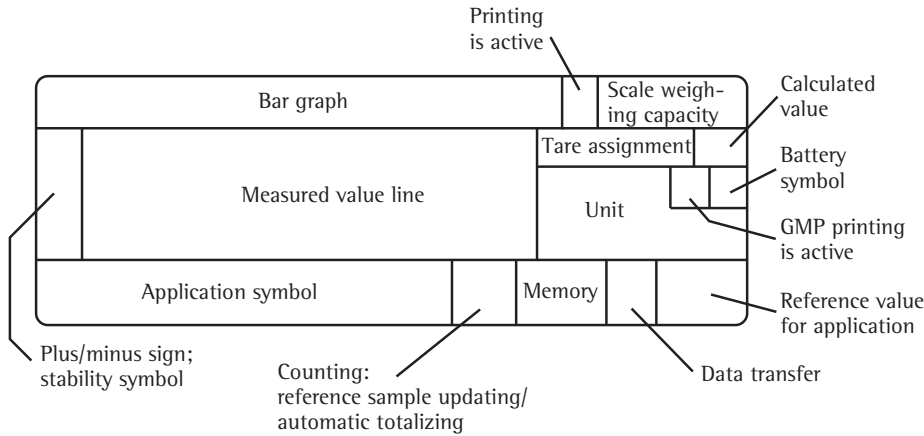

There are two display modes:

- Normal operation (weighing mode)
- Operating menu (for configuration)

### Weighing Mode: Display of Measured and Calculated Values

#### Application, printing and battery symbols:

The application symbol indicates the selected program, for example:

- ☼ Counting application
- Ⓞ Printing mode active
- Ⓞ GMP printing mode active



The battery symbol  indicates the charge level of the external rechargeable battery.

#### Bar graph

The bar graph shows the percentage of the weighing platform's capacity that is "used up" by the load on the scale (gross value).

- 0% Lower load limit
- 100% Upper load limit

The following symbols indicate tolerance levels for checkweighing:

-  Bar graph showing 10% intervals
-  Minimum for "checkweighing"
- $\neq$  Target value for "checkweighing"
-  Maximum for "checkweighing"

#### Plus or minus sign

+ or - for weight value or calculated value,  
 when the weighing platform is zeroed or tared (verified models only).

#### Line for measured values

This field shows weight values, calculated values and input characters.

#### Unit and stability:

When the weighing system reaches stability, the weight unit or calculation unit is displayed here.

#### Tare in memory, calculated values:

Meaning of Symbols:

-  Calculated value (not valid in legal-for-trade applications)
- NET Net value (gross value minus tare)
- B/G Gross value (net value plus tare)





#### Data in tare memory, calculated values, designation of the active weighing platform

*PT* Identification of manual tare input (using a barcode scanner) when viewing tare information.

*WP 1* Display of the active weighing platform when 2 platforms are connected. The symbol flashes to prompt adjustment of the weighing platform, if the isoCAL function is active.

#### Application symbols

For input and display of detailed information; e.g., for the selected application.

- ☼ Counting / Neutral measurement
- % Weighing in Percent
-  Averaging (animal weighing)
-  Checkweighing
-  Classification
-  Checkweighing toward zero
- $\Sigma$  Totalizing
-  Net-total Formulation

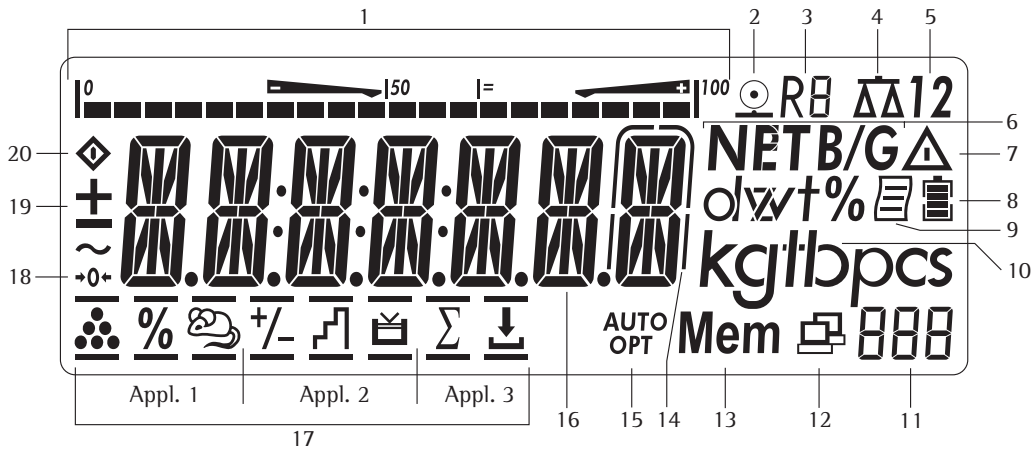

**Display in Weighing Mode**

The illustration above depicts all of the main display elements and symbols that can be shown during weighing.

- |  |  |  |
|--|--|--|
| <ol style="list-style-type: none"> <li>1. Bar graph             <ul style="list-style-type: none"> <li>- Shows the percentage of the weighing platform's capacity that is "used up" by the load on the scale (gross value), or</li> <li>- Shows the measured value in relation to a target value (with the Checkweighing or Classification application)</li> </ul> </li> <li>2. Symbol for current print job</li> <li>3. Displays the active range on multiple-range scales</li> <li>4. Indicates active weighing platform; flashes to prompt calibration/adjustment</li> <li>5. Selected weighing platform 1 or 2</li> <li>6. Net/Gross value on the main display (with tare in memory or preset tare)</li> <li>7. Identifies the value on the main display as calculated (value not valid in legal metrology)</li> <li>8. Battery symbol showing status of rechargeable battery (empty outline indicates battery is drained)</li> <li>9. GMP-compliant printing in progress</li> <li>10. Weight unit of the value displayed</li> </ol> | <ol style="list-style-type: none"> <li>11. Numeric display; e.g., showing reference value (Signum® 2 and 3 only)             <ul style="list-style-type: none"> <li>(Signum® 2 and 3 only):</li> </ul> </li> <li>12. Symbol indicating data transfer             <ul style="list-style-type: none"> <li>- Interface initialized</li> <li>- Flashes during data transfer</li> </ul> </li> <li>13. Symbol for product data memory (Signum® 3 only)</li> <li>14. In legal metrology, on equipment with <math>e \neq d</math>, the digit shown with a border must not be taken into account</li> <li>15. Auto/Opt (Signum® 2 and 3 only)             <ul style="list-style-type: none"> <li>- Auto: Depending on the weight value, a reaction is triggered in the application</li> <li>- Opt: Automatic optimization has taken place for the Counting application</li> </ul> </li> <li>16. Weight value or calculated value (main display)</li> <li>17. Applications symbols for applications in Signum® 2 and 3:             <ul style="list-style-type: none"> <li>Application 1:                 <ul style="list-style-type: none"> <li>☉ Counting / Neutral measurement</li> <li>% Weighing in Percent</li> <li>☞ Averaging (animal weighing)</li> </ul> </li> <li>Application 2:                 <ul style="list-style-type: none"> <li>☒ Checkweighing</li> <li>☒ Classification</li> <li>☒ Checkweighing toward zero<br/>Manually batching to a target value</li> </ul> </li> </ul> </li> </ol> | <p>Application 3:</p> <ul style="list-style-type: none"> <li>☒ Totalizing</li> <li>☒ Net-total Formulation</li> </ul> <p>Verified models only:</p> <ol style="list-style-type: none"> <li>18. The zero-setting symbol is displayed after the active scale or weighing platform has been zeroed</li> <li>19. Plus or minus sign of the value displayed</li> <li>20. Busy symbol indicates that an internal process in progress</li> </ol> |
|--|--|--|

**Saving During Weighing**

All of the application parameters saved (e.g., reference values) remain in memory and are still available after

- Signum® has been switched off and on
- you return to the originally selected application from a second one (e.g., when you switch from Averaging back to Counting, all parameters saved for Counting are available)

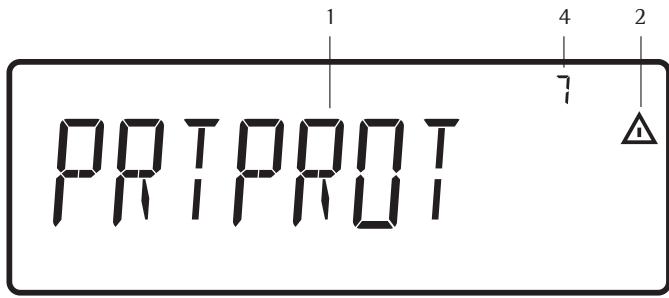

Setup Menu Display: Text Menu (Example)

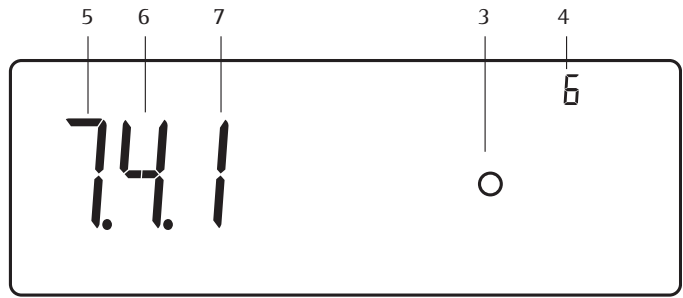

Setup Menu Display: Numeric operating menu (example)

### Menu Operating Design

The keys below the display are used to navigate and make entries in the device menu.

#### Opening the Menu

Press the key to switch the device off and then on again; while all segments are displayed, press the key briefly.

#### Navigating the Menu

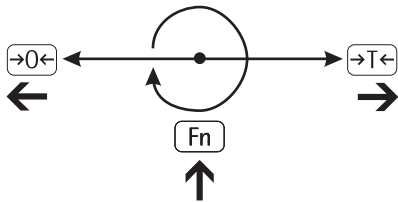

Exit the active submenu and return to the next higher menu level (back).

- Press briefly: select and save a menu item.  
- Press and hold (>2 seconds): Exit the menu

Show the next item on the same menu level (the display scrolls through all items in series).

Print the menu settings starting from the current position, or print Info data.

#### Alphanumeric Input in the Menu

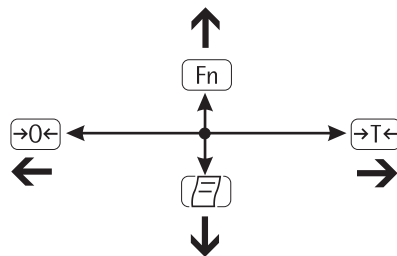

- Press briefly: Activate character to the left of the currently active character (when first character is active: exit the input mode without saving changes)  
- Press and hold (> 2 seconds): Exit the input mode without saving changes

- Press briefly: Confirm currently active character and move 1 position to the right (after the last character: save input)  
- Press and hold (> 2 seconds): Save current input and display the menu item

- Cursor in first position, no characters entered yet: Delete character(s) and enter 0  
- Change the displayed character; scroll forward (sequence: 0 through 9, decimal point, minus sign, Z through A, space)

- Cursor in first position, no characters entered yet: Delete character(s) and enter a space  
- Change the displayed character; scroll backwards (sequence: space, A ... Z, minus sign, decimal point, 9 ... 0)

#### Numeric input in the Signum® 3 operating menu

Enter values (date and time, etc.) using the 10-key numeric keypad

#### Menu Display

The illustration above depicts all of the main display elements and symbols that can be shown in the Setup menu.

- 1 Selected menu item at text level (e.g. printer for setting the connected printer)
- 2 Note that other submenus are available
- 3 Current active setting
- 4 Menu history (note at highest menu level in the Setup menu)
- 5 First level in the Setup menu
- 6 Second level in the Setup menu
- 7 Third level in the Setup menu

#### Saving Menu Settings

The parameters selected in the operating menu remain saved after you switch off the Signum®. You can block access to Setup in the device menu by assigning a password. This will prevent unauthorized changes to selected menu parameters.

## Error messages

- If a key is inactive, “-----” and/ or “No function” is displayed briefly (2 sec.)
- Temporary errors are displayed for 2 seconds in the measured value/result line via an error code (e.g., Inf 09); fatal errors (e.g., Err 101) are displayed continuously until “Reset” is used.

Error codes are described in detail under “Error Codes” on page 92.

## Data Output

### Printer

You can connect two strip or label printers to Signum® 1, 2 or 3. You can generate printouts at the press of a key or automatically. Printout formats are user-definable. You can also configure separate summarized printouts, and print a list of the active menu settings. See “Configuring Printouts,” page 81, for details.

## Digital Input/Output Interface + Optional I/O

The digital I/O interface is supported by the Checkweighing and Classification applications (Signum® 2 and 3 only):

### Checkweighing

The output device has a number of control functions. Four data outputs transfer signals for “less than,” “equal to,” “greater” and “set.” You can define whether the outputs are always active or are activated only at stability, only within the checkweighing range, only within the checkweighing range at stability, or switched off.

### Classification

Four data outputs transfer information on the class of the load (Class 1, 2, 3, 4 or 5) and indicate when the minimum load is exceeded (Set).

You can define whether the outputs are always active, activated only at stability, or off. For details, see “Classification” in the enclosed “Basic Application Programs” manual for details.

## Communication Interface

You can define a number of parameters for this SBI interface (print command, time-dependent autoprint, ID codes). See “Interface Port,” page 84, for details.

## Backups

Signum® 2 and 3 saves all application parameters (e.g. reference values) when the device is turned off or you switch between application programs. You can assign a password to prevent unauthorized users from changing settings in the “Device parameters” menu under:

```

SETUP
└── PASSWORD
  
```

See also page 17.



## Settings

You can configure the Signum by selecting parameters in the Setup menu. These are divided into the following groups (menu level 1):

- Application parameters
- Fn key function
- Device parameters
- Device-specific information "INFO"
- Language

When used in legal metrology, not all parameters can be accessed.

Factory-set parameters are identified by an "\*" in the list starting on page 19.

You can choose from five languages for the display of information:

- German
- English (factory setting)
- English with U.S. date/time
- French
- Italian
- Spanish

### Printing parameter settings:

- Press the  key in Setup

Scope of printout:

Depends on the position in Setup

## Setting the Language

**Example:** Selecting "US Mode" for the language



Turn on the device

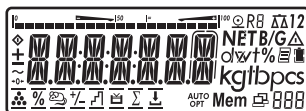

While all segments are lit, press the  key

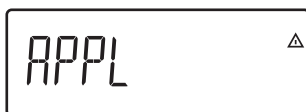

The first item in the Main menu is shown: *APPL*



Switch to the *LANG* menu item (press  repeatedly until *LANG* is shown)

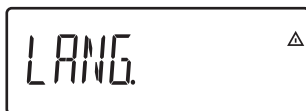

Select *LANG* to open the submenu for setting the language

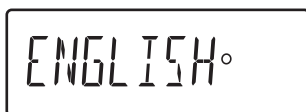

The currently active language is shown



Switch to the *US MODE* menu item (press  repeatedly until *US MODE* is displayed)



Save the menu item



Exit this menu level and configure other settings as desired, or





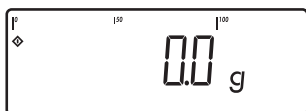





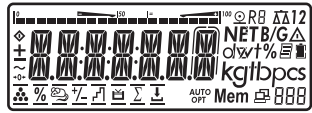





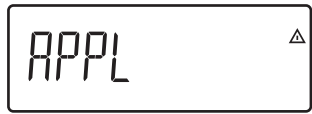





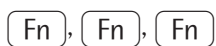



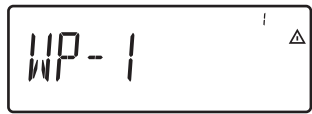









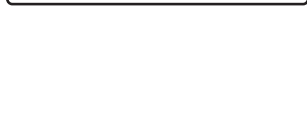

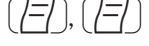
Exit the menu



### Protecting Setup With a User Password

**Example:** Assign a password (in this example, AB2) to protect the application program settings APPL and the device parameters SETUP from unauthorized changes

- |  |  |   |   |
|--|--|---|---|
| <br>     | <p>1.) Turn on the Signum®</p>   | <br>    | <p>9.) Enter the second character using the  and  keys (in this example: B)</p> |
| <br>     | <p>2.) While all segments are lit, press .<br/><br/>The first item in the Main menu is shown: APPL</p>  | <br>     | <p>10.) Save the character</p>  |
| <br>     | <p>3.) Select the <i>SETUP</i> menu item (press  repeatedly until <i>SETUP</i> is displayed)</p>  | <br>    | <p>11.) Enter the third character using the  and  keys (in this example: 2)</p> |
| <br> | <p>4.) Open the <i>SETUP</i> menu</p>  | <br> | <p>12.) Save the password</p>   |
| <br> | <p>5.) Select the <i>U-CODE</i> menu item (press  repeatedly until <i>U-CODE</i> is displayed)</p>  | <br> | <p>13.) Exit this menu level and configure other settings as desired, or</p>  |
| <br> | <p>6.) Open the User Password menu item</p>  | <br> | <p>14.) Exit the menu (press and hold the  key)</p>  |
| <br> | <p>7.) Enter the first character using the  and  keys (in this example: A)</p> |   | <p><b>To delete a password:</b><br/>Overwrite the old password with the new password, or enter a space as the password and press  to confirm</p>                 |
| <br> | <p>8.) Save the character</p>  |   |   |

## Operating Menu Overview

In the Setup menu, you can configure the indicator to meet your individual requirements. User data can be entered and pre-set parameters selected.

Menu levels are identified by texts, and numeric codes identify the individual settings.

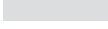
 = Setting/Function available for Signum® 1 only  
 = Setting/Function available for Signum® 2 and 3 only

1st Level Display	2nd Level Display	Meaning
Menu		
APPL		Select and configure application programs
	⚖ / WEIGH.	Basic weighing function
	⦿ / COUNT.	Counting
	⦿ NM / NEUTR.M	Neutral measurement
	🐾 / ANIM.WG	Averaging (animal weighing)
	⚖ / CHECK.WG	Checkweighing
	📊 / CLASS.	Classification
	% / PERC.WG	Weighing in percent
	⬇ / NET TOT	Net-total formulation
	∑ / TOTALIZ	Totalizing
FN-KEY		Define the function of the <b>[Fn]</b> key
	OFF	No function
	GRO/NET	Gross/Net toggling (Signum® 1 only)
	2.UNIT	Display 2nd weight unit
	RES 10	10-fold increased resolution (Signum® 1 only)
	SQMIN	Display the minimum permissible sample quantity <sup>1)</sup>
SETUP		Customize Signum® to user requirements
	WP-1	Settings for weighing platform 1
	COM1	Settings for the RS-232 interface
	UNICOM	Settings for the optional second interface
	COMSPEC	Reference scale connection: A/D converter configuration (optional)
	CTRL IN	Function setting for universal input (control line)
	BARCODE	Barcode scanner function settings
	PRTPROT	Printout settings
	UTILIT	Operating parameters
	TIME <sup>2)</sup>	Time settings
	DATE <sup>2)</sup>	Date settings
	U-CODE	User password to protect settings
	SQMIN	User options: – Display minimum permissible sample quantity – Include SQmin in GLP printout
	CLR.LEG.S (optional)	Clear alibi memory (only in service mode)
	LEG.S.PER (optional)	Alibi memory retention period
INFO		Display device-specific information (service date, serial number, etc.)
LANG		Language selection for calibration, adjustment and GMP printouts
	DEUTSCH	German
	ENGLISH	English
	US MODE	English with U.S. date/time
	FRANC	French
	ITAL	Italian
	ESPAÑOL	Spanish

<sup>1)</sup> Only active when minimum sample quality has been entered by Service and menu item: SQMIN: DISPLAY: ON

<sup>2)</sup> Only active when the device is equipped with a clock module.

## Operating Menu

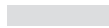
-  = Setting/Function available for Signum® 1 and 2 only  
 = Setting/Function available for Signum® 2 and 3 only

\* Factory setting

Menu

APPL		Application programs	
APPL 1 <sup>1)</sup>		<b>ΔΔ / WEIGH.</b>	<b>Basic weighing function</b>
3.5.		3.5.1 *	Minimum load for automatic taring and automatic printing
3.5.2		3.5.2	1 digit
3.5.3		3.5.3	2 digits
3.5.4		3.5.4	5 digits
3.5.5		3.5.5	10 digits
3.5.6		3.5.6	20 digits
3.5.7		3.5.7	50 digits
3.5.8		3.5.8	100 digits
3.5.9		3.5.9	200 digits
3.5.10		3.5.10	500 digits
3.7.		3.7.1 *	1000 digits
3.7.1 *		3.7.2	Automatic taring: first weight tared
3.7.2		3.7.2	Off
3.25.		3.25.1	On
3.25.1		3.25.2	Tare function
3.25.2		3.25.2	Can add a preset tare if tare value is available; however no tare function possible
9.1.		9.1.1 *	When a preset tare is entered, the tare value is deleted; however tare function activation is possible
9.1.1 *		9.1.2 *	Factory settings for all application programs
9.1.2 *		9.1.2 *	Yes
		9.1.2 *	No
			<b>Counting</b>
			Minimum load for automatic taring and automatic printing <sup>2)</sup>
			1 digit
			2 digits
			5 digits
			10 digits
			20 digits
			50 digits
			100 digits
			200 digits
			500 digits
			1000 digits
			Minimum load for initialization
			1 digit
			2 digits
			5 digits
			10 digits
			20 digits
			50 digits
			100 digits
			200 digits
			500 digits
			1000 digits
			Automatic taring: first weight tared
			Off
			On
			Automatic start of applications when you switch on the device with most recently saved application data <sup>2)</sup>
			Automatic (On)
			Manual (Off)
			Resolution for calculation of reference value
			Display accuracy
			Display accuracy + 1 decimal place
			Display accuracy + 2 decimal places
			Internal resolution
			Parameter for saving weight values
			With stability
			With increased stability
			Average piece weight updating
			Off
			Automatic
			Reference weighing instrument
			No weighing platform selected
			Weighing platform WP 1
			Weighing platform WP 2
			Tare function <sup>2)</sup>
			Can add a preset tare if tare value is available; however no tare function possible
			When a preset tare is entered, the tare value is deleted; however tare function activation is possible
			Factory settings for all application programs <sup>2)</sup>
			Yes
			No

<sup>1)</sup> Setup level for Signum® 3 only

<sup>2)</sup> For Signum® 2 only

APPL

APPL 1<sup>1)</sup>

 NM / NEUTR.M

**Neutral measurement**

- 3.5. \_\_\_\_\_ Numeric menu similar to Counting Minimum load for automatic taring and automatic printing<sup>2)</sup>
- 3.6. \_\_\_\_\_ Numeric menu similar to Counting Minimum load for initialization
- 3.7. \_\_\_\_\_ Numeric menu similar to Counting Automatic taring: first weight tared<sup>2)</sup>
- 3.8. \_\_\_\_\_ Numeric menu similar to Counting Automatic start of applications when you switch on the device with most recently saved application data<sup>2)</sup>
- 3.9. \_\_\_\_\_ Reference value calculation resolution
  - 3.9.1 \* \_\_\_\_\_ Display accuracy
  - 3.9.2 \_\_\_\_\_ Display accuracy + 1 decimal place
  - 3.9.3 \_\_\_\_\_ Display accuracy + 2 decimal places
  - 3.9.4 \_\_\_\_\_ Internal resolution
- 3.10. \_\_\_\_\_ Decimal places in displayed result
  - 3.10.1 \* \_\_\_\_\_ none
  - 3.10.2 \_\_\_\_\_ 1 decimal place
  - 3.10.3 \_\_\_\_\_ 2 decimal places
  - 3.10.4 \_\_\_\_\_ 3 decimal places
- 3.11. \_\_\_\_\_ Parameter for saving weight values
  - 3.11.1 \* \_\_\_\_\_ With stability
  - 3.11.2 \_\_\_\_\_ With increased stability
- 3.13. \_\_\_\_\_ Reference weighing instrument
  - 3.13.1 \* \_\_\_\_\_ No weighing platform selected
  - 3.13.2 \_\_\_\_\_ To weighing platform WP 1
  - 3.13.3 \_\_\_\_\_ To weighing platform WP 2
- 3.25. \_\_\_\_\_ Tare function<sup>2)</sup>
  - \_\_\_\_\_ Numeric menu similar to Counting
- 9.1. \_\_\_\_\_ Factory settings for all application programs<sup>2)</sup>
  - 9.1.1 \_\_\_\_\_ Yes
  - 9.1.2 \_\_\_\_\_ No

 ANIM.WG

**Averaging (animal weighing)**

- 3.5. \_\_\_\_\_ Numeric menu similar to Counting Minimum load for automatic taring and automatic printing<sup>2)</sup>
- 3.6. \_\_\_\_\_ Numeric menu similar to Counting Minimum load threshold for automatic start
- 3.7. \_\_\_\_\_ Numeric menu similar to Counting Automatic taring: first weight tared<sup>2)</sup>
- 3.8. \_\_\_\_\_ Numeric menu similar to Counting Automatic start of applications when you switch on the device with most recently saved application data<sup>2)</sup>
- 3.18. \_\_\_\_\_ Start of averaging
  - 3.18.1 \* \_\_\_\_\_ Manual
  - 3.18.2 \_\_\_\_\_ Automatic
- 3.19. \_\_\_\_\_ Animal activity
  - 3.19.1 \_\_\_\_\_ 0.1% of the animal/object
  - 3.19.2 \* \_\_\_\_\_ 0.2% of the animal/object
  - 3.19.3 \_\_\_\_\_ 0.5% of the animal/object
  - 3.19.4 \_\_\_\_\_ 1% of the animal/object
  - 3.19.5 \_\_\_\_\_ 2% of the animal/object
  - 3.19.6 \_\_\_\_\_ 5% of the animal/object
  - 3.19.7 \_\_\_\_\_ 10% of the animal/object
  - 3.19.8 \_\_\_\_\_ 20% of the animal/object
  - 3.19.9 \_\_\_\_\_ 50% of the animal/object
  - 3.19.10 \_\_\_\_\_ 100% of the animal/object
- 3.20. \_\_\_\_\_ Results printout
  - 3.20.1 \* \_\_\_\_\_ Manual
  - 3.20.2 \_\_\_\_\_ Automatic
- 3.21. \_\_\_\_\_ Static display of result after load removed
  - 3.21.1 \* \_\_\_\_\_ Display is fixed until unload threshold reached
  - 3.21.2 \_\_\_\_\_ Fixed display until [CF] is pressed
- 3.25. \_\_\_\_\_ Tare function<sup>2)</sup>
  - 3.25.1 \* \_\_\_\_\_ Can add a preset tare if tare value is available; however no tare function possible
  - 3.25.2 \_\_\_\_\_ When a preset tare is entered, the tare value is deleted; however tare function activation is possible
- 9.1. \_\_\_\_\_ Factory settings for all application programs<sup>2)</sup>
  - 9.1.1 \_\_\_\_\_ Yes
  - 9.1.2 \* \_\_\_\_\_ No

<sup>2)</sup> For Signum<sup>®</sup> 2 only

-APPL

APPL 1<sup>1)</sup>

% / PERC.WG

**Weighing in Percent**

- 3.5. Minimum load for automatic taring and automatic printing<sup>2)</sup>  
Numeric menu similar to Counting
- 3.6. Minimum load for initialization  
Numeric menu similar to Counting
- 3.7. Automatic taring: first weight tared<sup>2)</sup>  
Numeric menu similar to Counting
- 3.8. Automatic start of applications when you switch on the device with most recently saved application data<sup>2)</sup>  
Numeric menu similar to Counting
- 3.9. Reference value calculation resolution
  - 3.9.1 \* Display accuracy
  - 3.9.2 Display accuracy + 1 decimal place
  - 3.9.3 Display accuracy + 2 decimal places
  - 3.9.4 Internal resolution
- 3.10. Decimal places in displayed result
  - 3.10.1 \* none
  - 3.10.2 1 decimal place
  - 3.10.3 2 decimal places
  - 3.10.4 3 decimal places
- 3.11. Parameter for saving weight values
  - 3.11.1 \* With stability
  - 3.11.2 With increased stability
- 3.13. Reference weighing instrument
  - 3.13.1 \* Off
  - 3.13.2 To weighing platform WP 1
  - 3.13.3 To weighing platform WP 2
- 3.15. Display of calculated values
  - 3.15.1 \* Residue
  - 3.15.2 Loss
- 3.25. Tare function<sup>2)</sup>  
Numeric menu similar to Counting
- 9.1. Factory settings for all application programs<sup>2)</sup>
  - 9.1.1 Yes
  - 9.1.2 No

APPL 2<sup>1)</sup>

% / CHECK.WG

**Checkweighing**

- 3.5. Minimum load for automatic taring and automatic printing<sup>2)</sup>  
Numeric menu similar to Counting
- 3.7. Automatic taring: first weight tared<sup>2)</sup>  
Numeric menu similar to Counting
- 3.8. Automatic start of applications when you switch on the device with most recently saved application data<sup>2)</sup>  
Numeric menu similar to Counting
- 3.25. Tare function<sup>2)</sup>  
Numeric menu similar to Counting
- 4. 2. Checkweighing range
  - 4.2.1 \* 30 to 170%
  - 4.2.2 10% to infinity
- 4. 3. Control output for SET as:
  - 4.3.1 \* SET output
  - 4.3.2 Ready to operate (for process control systems)
- 4. 4. Activation of outputs
  - 4.4.1 Off
  - 4.4.2 Always on
  - 4.4.3 At stability
  - 4.4.4 Within checkweighing range
  - 4.4.5 On at stability within checkweighing range
- 4. 5. Parameter input
  - 4.5.1 \* Min, Max, target value
  - 4.5.2 Only target value with percent limits
  - 4.5.3 Set point with free limits percent
  - 4.5.4 Set point; Min, Max value as relative weights to the set point
- 4. 6. Automatic printing
  - 4.6.1 \* Off
  - 4.6.2 On
  - 4.6.3 Only values within tolerance
  - 4.6.4 Only values outside tolerance
- 4. 7. Checkweighing toward zero
  - 4.7.1 \* Off
  - 4.7.2 On
- 9.1. Factory settings for all application programs<sup>2)</sup>
  - 9.1.1 Yes
  - 9.1.2 No

<sup>1)</sup> Setup level for Signum® 3 only <sup>2)</sup> For Signum® 2 only

APPL			
APPL 2 <sup>1)</sup>			<b>CLASS.</b>
			<b>Classification</b>
3.5.	_____	Numeric menu similar to Counting	Minimum load for automatic taring and automatic printing <sup>2)</sup>
3.6.	_____	Numeric menu similar to Counting	Minimum load for initialization
3.7.	_____	Numeric menu similar to Counting	Automatic taring: first weight tared <sup>2)</sup>
3.8.	_____	Numeric menu similar to Counting	Automatic start of applications when you switch on the device with most recently saved application data <sup>2)</sup>
3.25.	_____	Numeric menu similar to Counting	Tare function <sup>2)</sup>
4.3.	_____		Control output for SET as:
4.3.1 *	_____		SET output
4.3.2	_____		Ready to operate for process control systems
4.7.	_____		Activation of outputs
4.7.1	_____		Off
4.7.2	_____		Always on
4.7.3 *	_____		On at stability
4.8.	_____		Number of classes
4.8.1 *	_____		3 classes
4.8.2	_____		5 classes
4.9.	_____		Parameter input
4.9.1 *	_____		Weight values
4.9.2	_____		Percentage
4.10.	_____		Automatic printing
4.10.1 *	_____		Off
4.10.2	_____		On
9.1.	_____		Factory settings for all application programs <sup>2)</sup>
9.1.1	_____		Yes
9.1.2	_____		No
OFF <sup>1)</sup>			
APPL 3 <sup>1)</sup>			
		<b>NET TOT</b>	<b>Net-total Formulation (Second Tare Memory)</b>
3.5.	_____	Numeric menu similar to Counting	Minimum load for automatic taring and automatic printing <sup>2)</sup>
3.6.	_____	Numeric menu similar to Counting	Minimum load for initialization
3.7.	_____	Numeric menu similar to Counting	Automatic taring: first weight tared <sup>2)</sup>
3.17.	_____		Individual/Component printout when saved
3.17.1	_____		Automatic printing off
3.17.2 *	_____		Print the entire standard print configuration every time with the <b>[OK]</b> key
3.17.3	_____		Print the entire standard print configuration once with the <b>[OK]</b> key
3.25.	_____	Numeric menu similar to Counting	Tare function <sup>2)</sup>
9.1.	_____		Factory settings for all application programs <sup>2)</sup>
9.1.1	_____		Yes
9.1.2	_____		No

<sup>1)</sup> Setup level for Signum<sup>®</sup> 3 only

<sup>2)</sup> For Signum<sup>®</sup> 2 only



TOTALIZ		Totalizing
3.5.	Numeric menu similar to Counting	Minimum load for automatic taring and automatic printing <sup>2)</sup>
3.6.	Numeric menu similar to Counting	Minimum load for initialization
3.7.	Numeric menu similar to Counting	Automatic taring: first weight tared <sup>2)</sup>
3.8.	Numeric menu similar to Counting	Automatic start of applications when you switch on the device with most recently saved application data <sup>2)</sup>
3.16.		Autosave mode
3.16.1 *		Off
3.16.2		On
3.17.		Individual/Component printout when saved
3.17.1		Automatic printing off
3.17.2 *		Individual printout of an item with the <b>OK</b> key
3.22.		Source of values for data saved automatically
3.22.1 *		Application 1
3.22.2		Application 2
3.23.		Saved value
3.23.1 *		Net
3.23.2		Calculated
3.23.3		Net and Calculated
3.25.		Tare function <sup>2)</sup>
3.25.1		Keypad input added to tare comparison (weight value)
3.25.2		Tare value can be overwritten
9.1.		Factory settings for all application programs <sup>2)</sup>
9.1.1		Yes
9.1.2 *		No
OFF <sup>1)</sup>		

<sup>1)</sup> Setup level for Signum® 3 only

<sup>2)</sup> For Signum® 2 only

<p>APPL</p> <ul style="list-style-type: none"> <li>A.TARE 1)             <ul style="list-style-type: none"> <li>3.7.                 <ul style="list-style-type: none"> <li>3.7.1 *</li> <li>3.7.2</li> </ul> </li> </ul> </li> <li>M.WEIGH 1)             <ul style="list-style-type: none"> <li>3.5.                 <ul style="list-style-type: none"> <li>3.5.1 *</li> <li>3.5.2</li> <li>3.5.3</li> <li>3.5.4</li> <li>3.5.5</li> <li>3.5.6</li> <li>3.5.7</li> <li>3.5.8</li> <li>3.5.9</li> <li>3.5.10</li> </ul> </li> </ul> </li> <li>A.START 1)             <ul style="list-style-type: none"> <li>3.8.                 <ul style="list-style-type: none"> <li>3.8.1</li> <li>3.8.2 *</li> </ul> </li> </ul> </li> <li>SEL.CF 1)             <ul style="list-style-type: none"> <li>3.24.                 <ul style="list-style-type: none"> <li>3.24.1 *</li> <li>3.24.2</li> </ul> </li> </ul> </li> <li>TARE-F. 1)             <ul style="list-style-type: none"> <li>3.25.                 <ul style="list-style-type: none"> <li>3.25.1 *</li> <li>3.25.2</li> </ul> </li> </ul> </li> <li>DEF.APP 1)             <ul style="list-style-type: none"> <li>9.1.                 <ul style="list-style-type: none"> <li>9.1.1</li> <li>9.1.2 *</li> </ul> </li> </ul> </li> </ul>	<p><b>Automatic taring: first weight tared</b> Off On</p> <p><b>Minimum load for automatic taring and automatic printing</b> 1 digit 2 digits 5 digits 10 digits 20 digits 50 digits 100 digits 200 digits 500 digits 1000 digits</p> <p><b>Automatic start of applications when you switch on the device with most recently saved application data</b> Automatic (On) Manual (Off)</p> <p><b>Selective deleting with the <span style="border: 1px solid black; padding: 0 2px;">CF</span> key</b> Clears all applications Clears only selected applications</p> <p><b>Tare function</b> Can add a preset tare if tare value is available; however no tare function possible When a preset tare is entered, the tare value is deleted; however tare function activation is possible</p> <p><b>Factory settings for all application programs</b> Yes No</p>
---	--

1) For Signum® 3 only

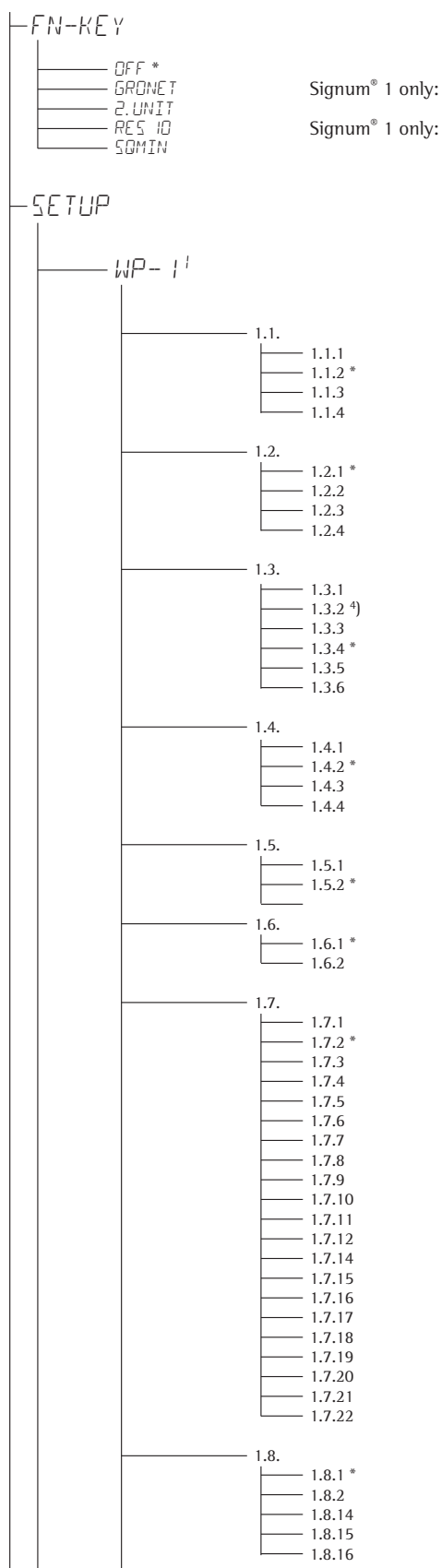

## Key assignment Fn

Fn key  
 Gross/Net toggling  
 Display of 2nd weight unit  
 10-fold increased resolution, display max. 5 seconds  
 Display the minimum permissible sample quantity <sup>3)</sup>

## Device Parameters

A password prompt is displayed if a password is configured

### Weighing platform 1

(Display designation of this menu level: !)

#### Adapting the scale to ambient conditions (filter adjustment)

Very stable conditions  
 Stable conditions  
 Unstable conditions  
 Very unstable conditions

#### Application filter

Final readout  
 Filling mode  
 Low filtering  
 Without filtering

#### Stability range

¼ digit  
 ½ digit  
 1 digit <sup>1)</sup>  
 2 digits <sup>1)</sup>  
 4 digits <sup>1)</sup>  
 8 digits <sup>1)</sup>

#### Stability delay

Without delay  
 Short delay  
 Average delay  
 Long delay

#### Taring <sup>1)</sup>

Without stability  
 At stability

#### Auto zero

On  
 Off

#### Weight unit 1 <sup>2)</sup>

Grams /o <sup>1)</sup>  
 Grams /g  
 Kilograms /kg  
 Carats /ct <sup>1)</sup>  
 Pounds /lb <sup>1)</sup>  
 Ounces /oz <sup>1)</sup>  
 Troy ounces /ozt <sup>1)</sup>  
 Hong Kong taels /tlh <sup>1)</sup>  
 Singapore taels /tls <sup>1)</sup>  
 Taiwan taels /tlt <sup>1)</sup>  
 Grains /GN <sup>1)</sup>  
 Pennyweights /dwt <sup>1)</sup>  
 Parts per pound /lb <sup>1)</sup>  
 Chinese taels /tlc <sup>1)</sup>  
 Mommies /mom <sup>1)</sup>  
 Austrian carats /K <sup>1)</sup>  
 Tola /tol <sup>1)</sup>  
 Baht /bat <sup>1)</sup>  
 Mesghal /MS <sup>1)</sup>  
 Tons /t <sup>1)</sup>  
 Pound: Ounces <sup>1)</sup>

#### Display accuracy 1 <sup>1)</sup>

All digits  
 Reduced by 1 decimal place for load change  
 10-fold increased resolution  
 Increase resolution by 2 scale intervals  
 Increase resolution by 1 scale interval

1) = Not available on equipment verified for use in legal metrology

2) = Depends on weighing platform model

3) = Only active when minimum sample quality has been entered by Service and menu item: SQMIN: DISPLAY:ON

4) = Factory setting for use in legal metrology

<p>SETUP WP-11</p> <ul style="list-style-type: none"> <li>1.9.             <ul style="list-style-type: none"> <li>1.9.1 *</li> <li>1.9.3</li> <li>1.9.4</li> <li>1.9.8</li> <li>1.9.9</li> <li>1.9.10</li> </ul> </li> <li>1.10.             <ul style="list-style-type: none"> <li>1.10.1</li> <li>1.10.2 *</li> </ul> </li> <li>1.11.             <ul style="list-style-type: none"> <li>1.11.1</li> <li>1.11.2 *</li> </ul> </li> <li>1.12.             <ul style="list-style-type: none"> <li>1.12.1 *</li> <li>1.12.2</li> <li>1.12.3 *</li> </ul> </li> <li>1.13.             <ul style="list-style-type: none"> <li>1.13.1 *</li> <li>1.13.2</li> <li>1.13.3</li> </ul> </li> <li>1.15.             <ul style="list-style-type: none"> <li>1.15.1 *</li> <li>1.15.2</li> </ul> </li> <li>1.16.             <ul style="list-style-type: none"> <li>1.16.1 *</li> <li>1.16.2 <sup>2)</sup></li> </ul> </li> <li>1.17.             <ul style="list-style-type: none"> <li>1.17.1 *</li> <li>1.17.2</li> <li>1.17.4 <sup>1)</sup></li> </ul> </li> <li>1.18.             <ul style="list-style-type: none"> <li>1.18.1</li> </ul> </li> <li>3. 1.             <ul style="list-style-type: none"> <li>3.1.1</li> <li>3.1.2</li> <li>3.1.3 *</li> <li>3.1.4</li> <li>3.1.5</li> <li>3.1.6</li> <li>3.1.7</li> <li>3.1.8</li> <li>3.1.9</li> <li>3.1.10</li> <li>3.1.11</li> <li>3.1.12</li> <li>3.1.14</li> <li>3.1.15</li> <li>3.1.16</li> <li>3.1.17</li> <li>3.1.18</li> <li>3.1.19</li> <li>3.1.20</li> <li>3.1.21</li> <li>3.1.22</li> </ul> </li> <li>3.2.             <ul style="list-style-type: none"> <li>3.2.1 *</li> <li>3.2.2</li> <li>3.2.14</li> <li>3.2.15</li> <li>3.2.16</li> </ul> </li> <li>3.3.</li> <li>3.4.</li> <li>9.1.             <ul style="list-style-type: none"> <li>9.1.1</li> <li>9.1.2 *</li> </ul> </li> </ul>	<p><b>Calibration and Adjustment</b>              Ext. calibration/adjustment; default weight              External calibration/adjustment; weight can be selected under menu item 1.18.1              Internal calibration/adjustment (models with built-in motorized calibration weight only)              Setting the preload              Deleting the preload              No function when you press the  key</p> <p><b>Calibration/Adjustment sequence</b>              Calibration with automatic adjustment              Calibration with manual adjustment</p> <p><b>Zeroing range</b>              1 percent/max. cap.              2 percent/max. cap.</p> <p><b>Initial zero point range</b>              Factory setting (depending on the model type)              2 percent/max. cap.              5 percent/max. cap.</p> <p><b>Tare/zero at power on:</b>              On              Off, load previous tare values              Only zero at power on</p> <p><b>Calibration prompt for connected IS weighing platform</b>              Off              Calibration prompt <math>\Delta\Delta</math> flashes on the display</p> <p><b>External calibration <sup>1)</sup></b>              Activated              Blocked</p> <p><b>Calibration weight unit <sup>3)</sup></b>              Grams              Kilogram              Pounds</p> <p><b>Entering calibration weight</b>              External user calibration weight (enter value, e.g.: 10,000 kg)</p> <p><b>Weight unit 2 <sup>3)</sup></b>              Grams /o <sup>1)</sup>              Grams /g              Kilograms /kg              Carats /ct <sup>1)</sup>              Pounds /lb <sup>1)</sup>              Ounces /oz <sup>1)</sup>              Troy ounces /ozt <sup>1)</sup>              Hong Kong taels /tlh <sup>1)</sup>              Singapore taels /tls <sup>1)</sup>              Taiwan taels /tlt <sup>1)</sup>              Grains /GN <sup>1)</sup>              Pennyweights /dwt <sup>1)</sup>              Parts per pound /lb <sup>1)</sup>              Chinese taels /tlc <sup>1)</sup>              Mommies /mom <sup>1)</sup>              Austrian carats /K <sup>1)</sup>              Tola /tol <sup>1)</sup>              Baht /bat <sup>1)</sup>              Mesghal /MS <sup>1)</sup>              Tons /t <sup>1)</sup>              Pound: Ounces <sup>1)</sup></p> <p><b>Display accuracy 2<sup>1)</sup></b>              All digits              Reduced by 1 decimal place for load change              10-fold increased resolution              Increase resolution by 2 scale intervals              Increase resolution by 1 scale interval</p> <p><b>Weight unit 3<sup>3)</sup>: Parameters, see 3.1 Weight unit 2</b></p> <p><b>Display accuracy 3<sup>1)</sup>: Parameters, see 3.2 Weight unit 2</b></p> <p><b>Restore factory settings in WP1 numeric menu</b>              Yes              No</p>
--	---

<sup>1)</sup> = Not available on instruments verified for use in legal metrology <sup>2)</sup> = Factory setting on instrument verified for use in legal metrology <sup>3)</sup> = Menu depends on weighing platform model

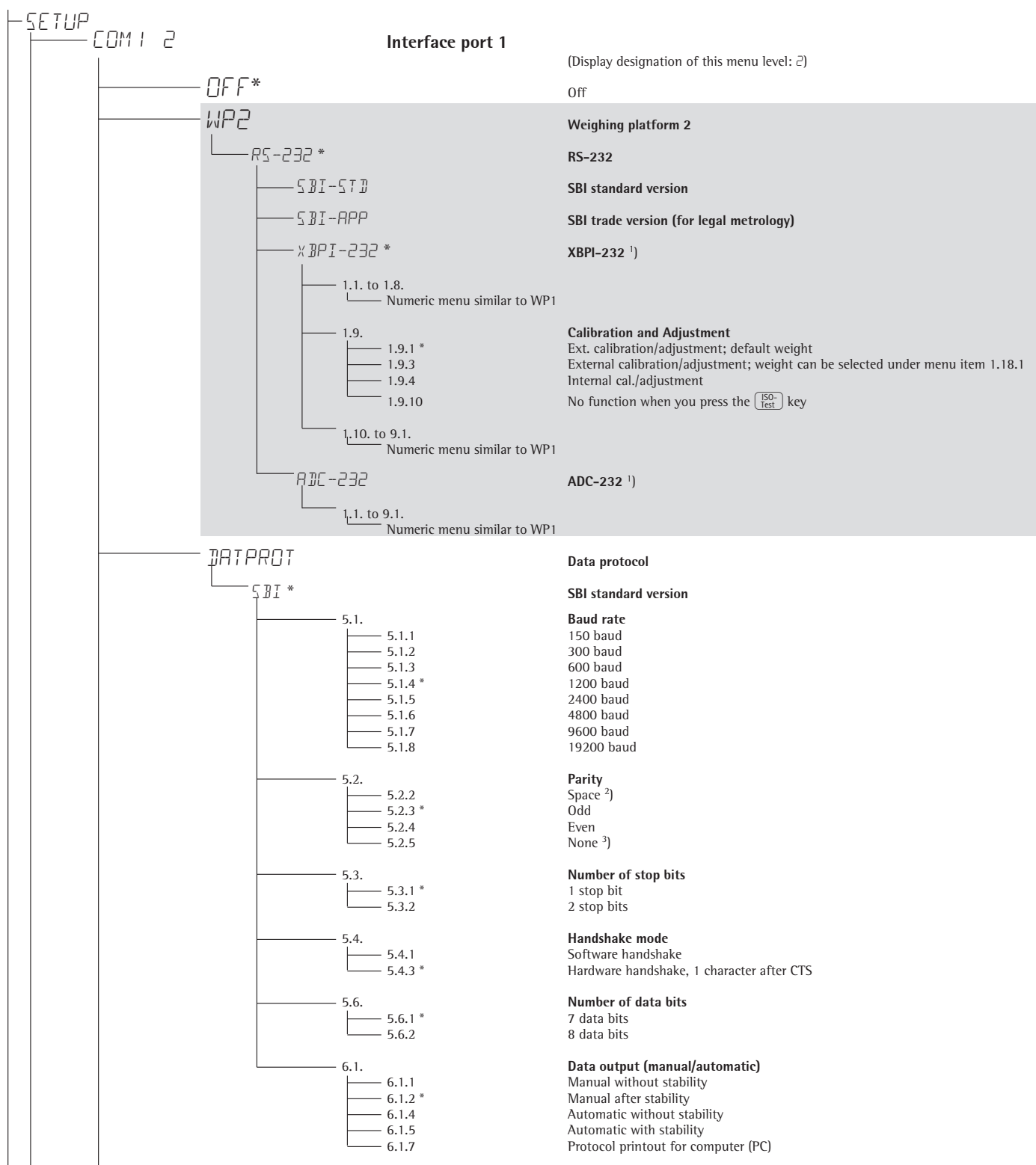

<sup>1)</sup> = Menu depends on weighing platform  
<sup>2)</sup> = Not for 5. 6. 2 (8 bits)  
<sup>3)</sup> = Not for 5. 6. 1 (7 bits)

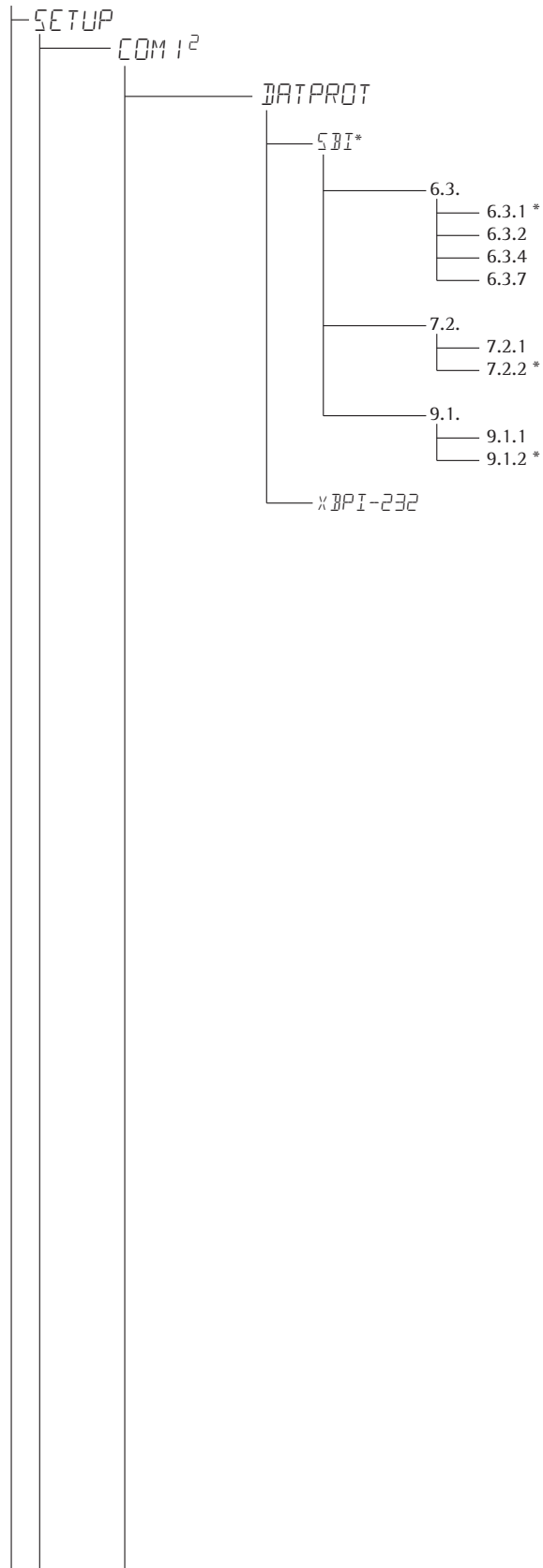

**Time-dependent automatic data output**

- 1 display update
- 2 display updates
- 10 display updates
- 100 display updates

**Data output: Line format**

- For raw data: 16 characters
- For other applications: 22 characters

**Restore factory settings in COM1 numeric menu: SBI**

- Yes
- No

**XBPI-232**

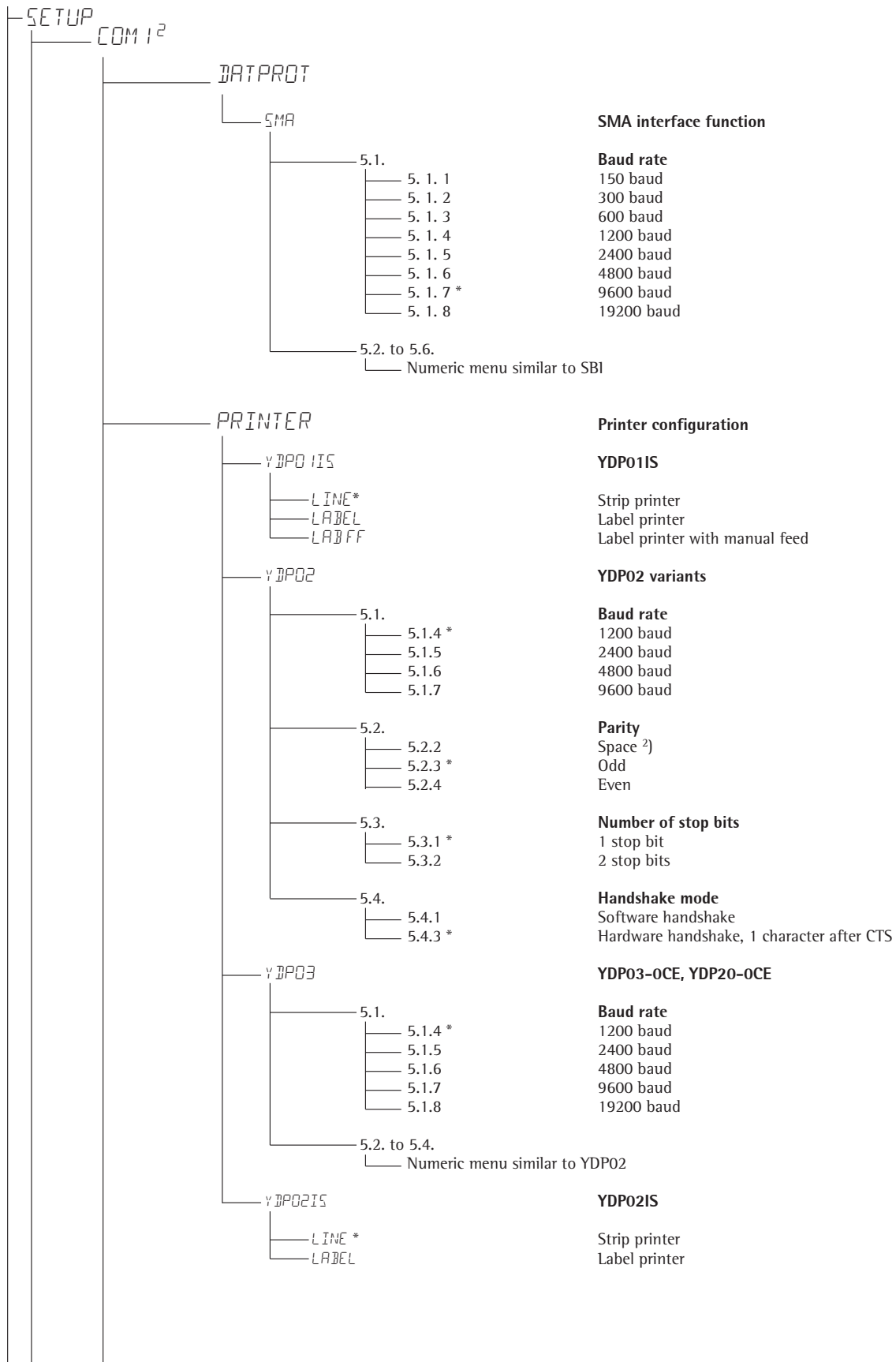

\* Factory setting



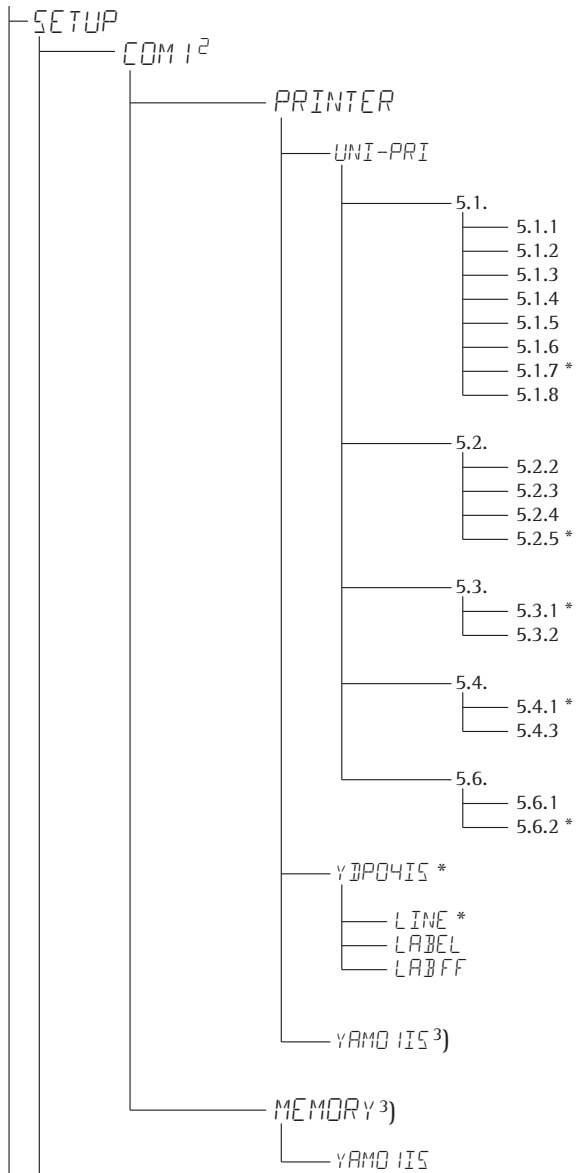

**Universal interface**

- Baud rate**  
 150 baud  
 300 baud  
 600 baud  
 1200 baud  
 2400 baud  
 4800 baud  
 9600 baud  
 19200 baud

- Parity**  
 Space <sup>1)</sup>  
 Odd  
 Even  
 None <sup>2)</sup>

- Number of stop bits**  
 1 stop bit  
 2 stop bits

- Handshake mode**  
 Software handshake  
 Hardware handshake, 1 character after CTS

- Number of data bits**  
 7 data bits  
 8 data bits

- YDP04IS**  
 Strip printer  
 Label printer  
 Label printer with manual feed

**YAM01IS as electronic memory for print data**

**Verifiable data memory**

**YAM01IS external data memory**

<sup>1)</sup> = Not for 5. 6. 2 (8 bits)  
<sup>2)</sup> = Not for 5. 6. 1 (7 bits)  
<sup>3)</sup> = Only if no internal alibi memory is active

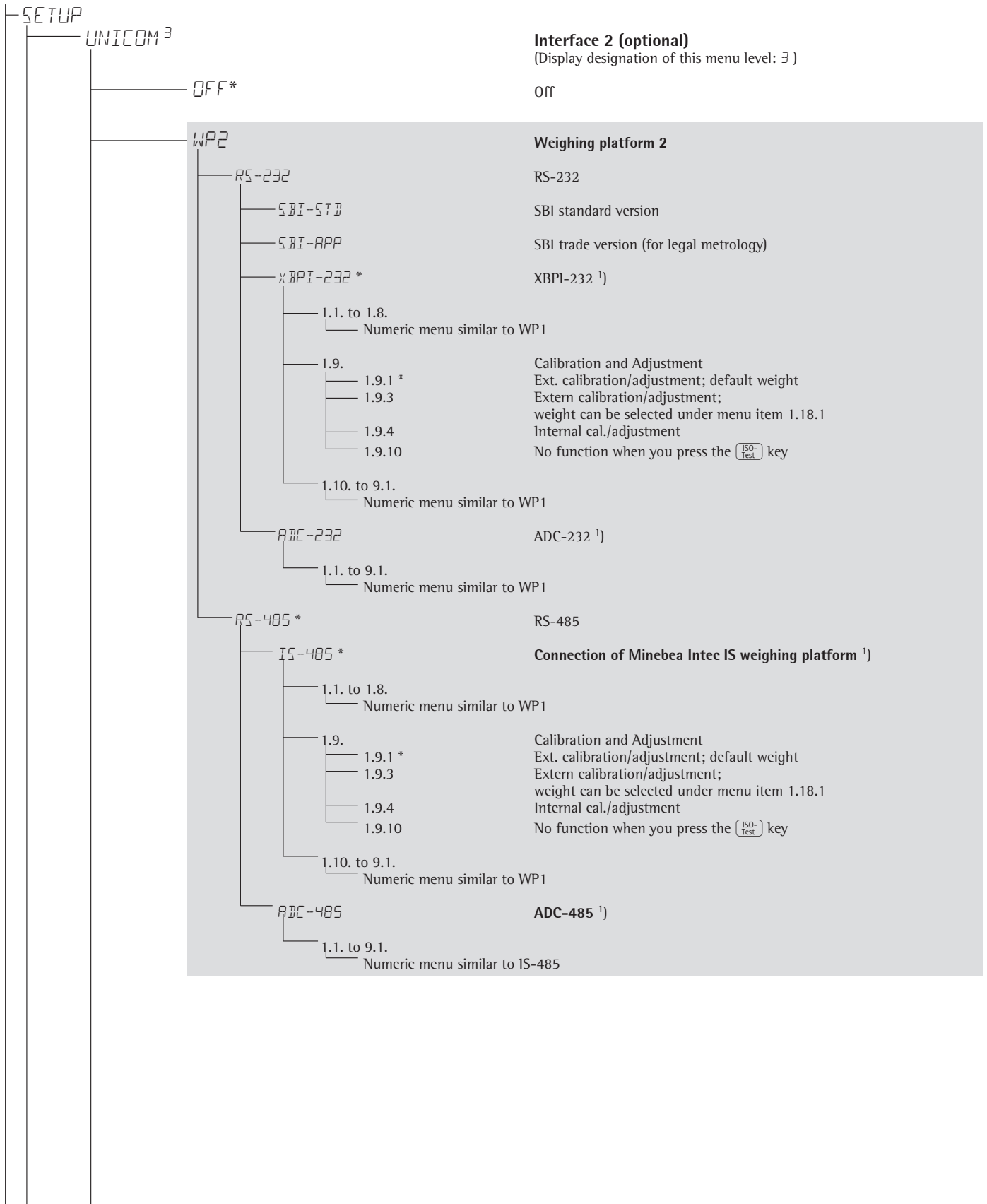

<sup>1)</sup> = Menu depends on weighing platform

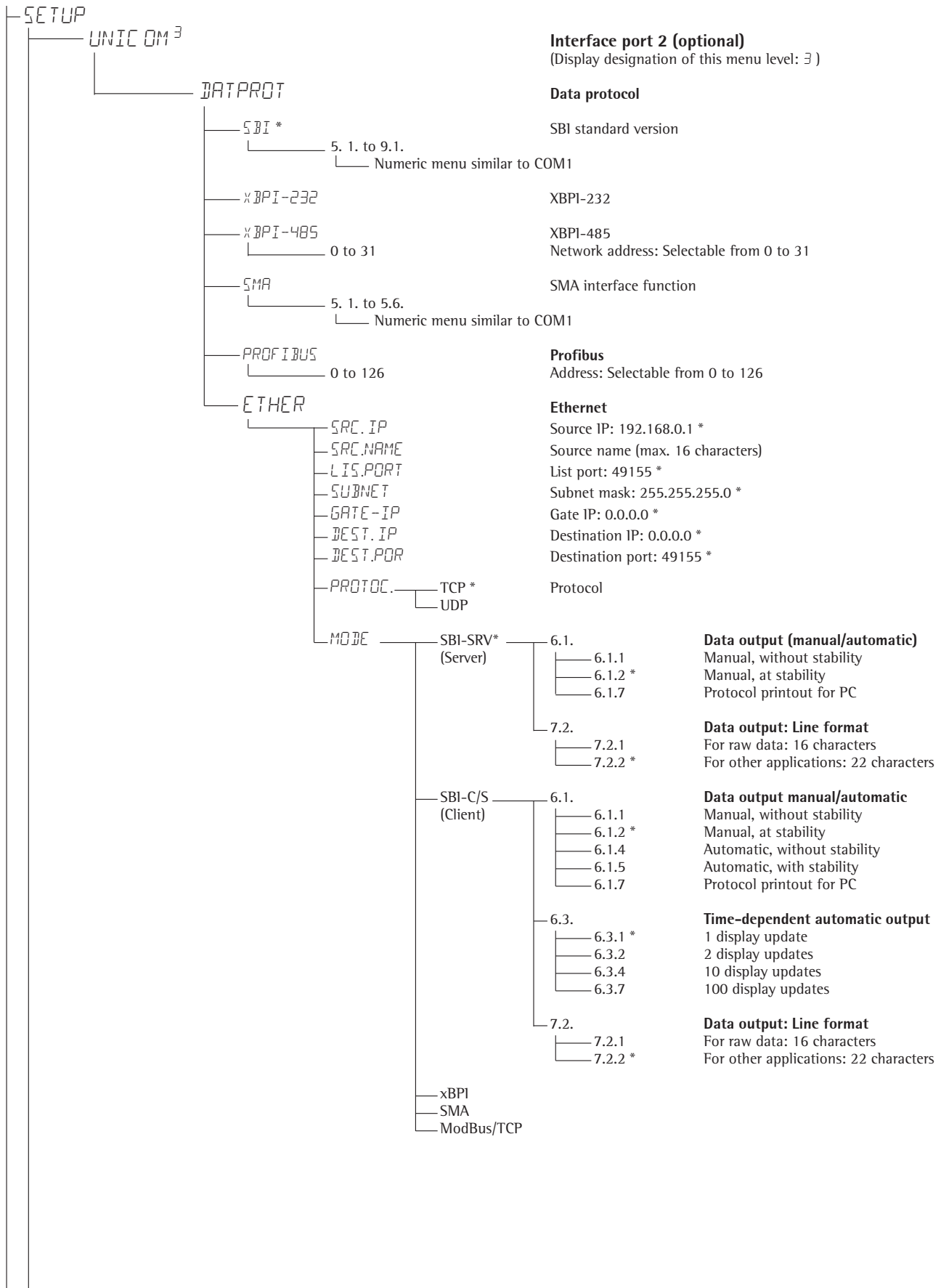

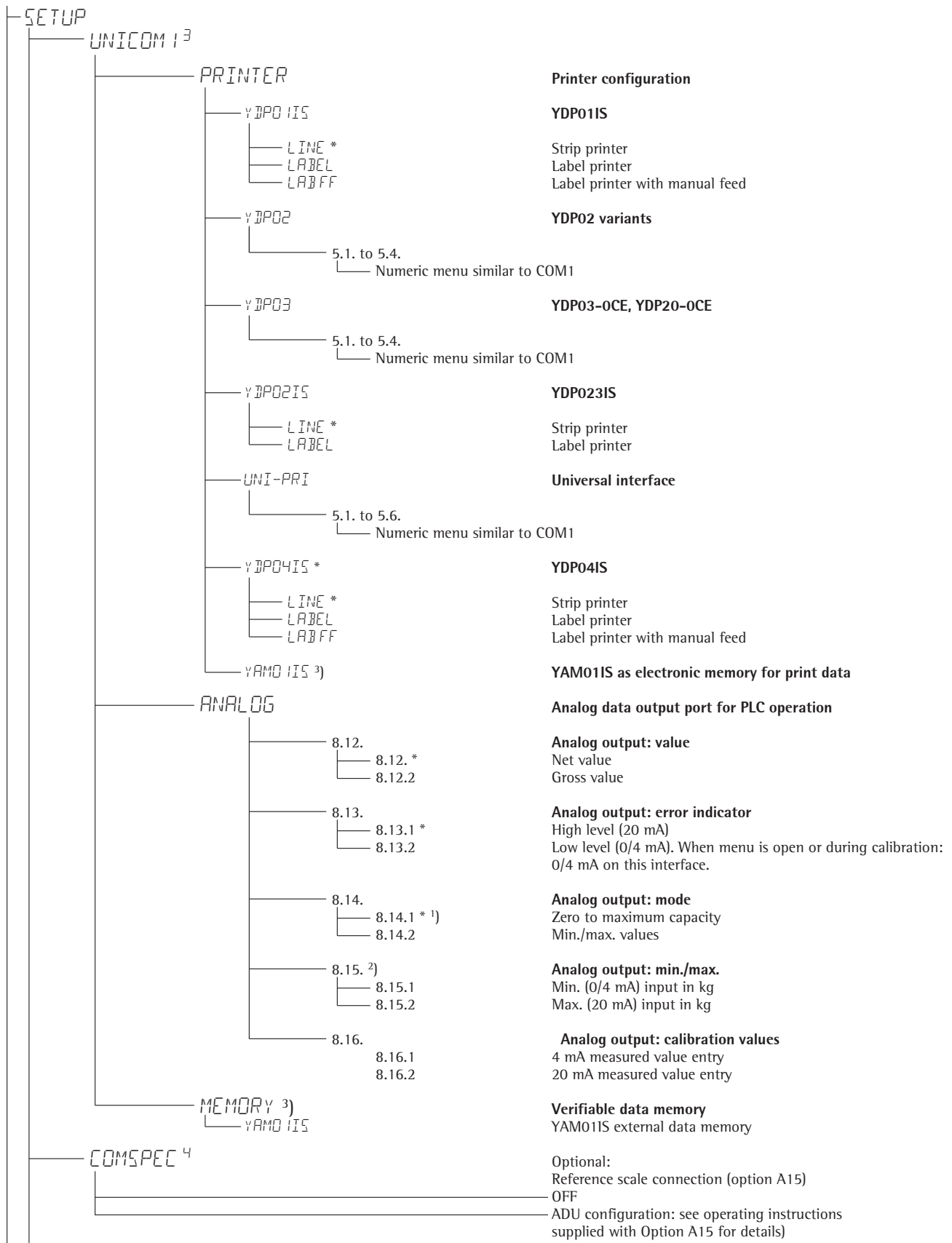

<sup>1)</sup> = When setting 8.14.1 is active, analog data output only works for XBP1 weighing instruments

<sup>2)</sup> = Not with setting 8.14.1

<sup>3)</sup> = Only if no internal alibi memory is available

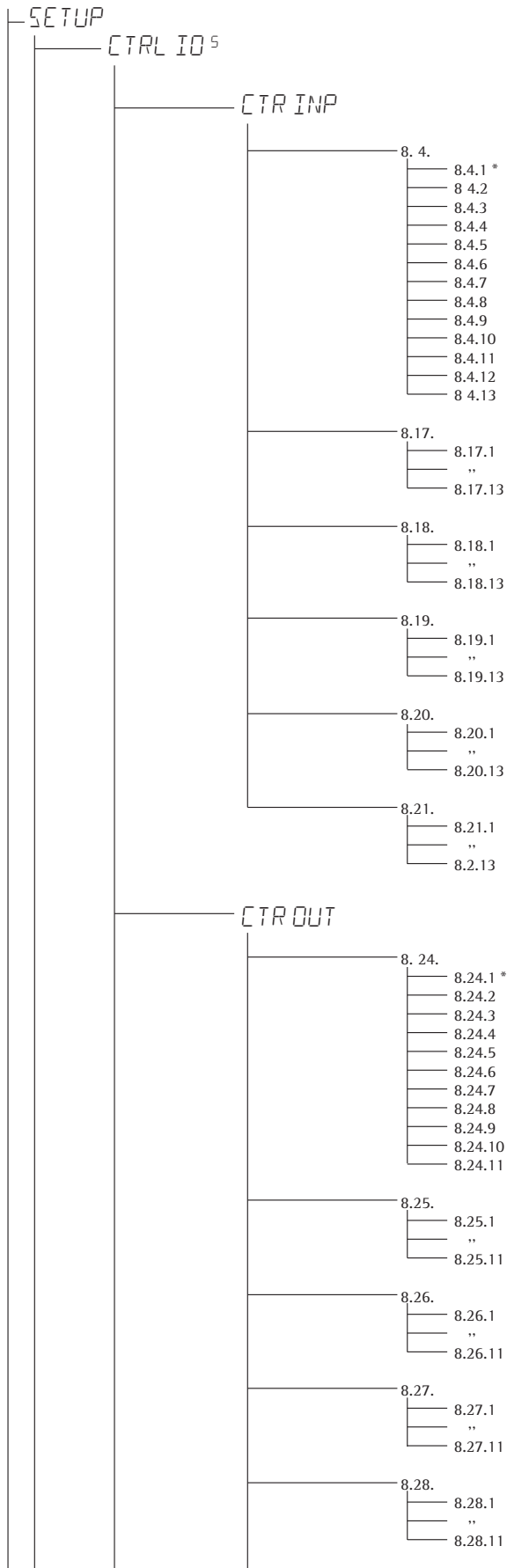

**External key**

(Display designation of this menu level: 5 )

**Input ports**

**Function for external key (universal)**

- Trigger key function
- Trigger "long" key function
- Trigger key function
- Trigger key function
- Trigger key function
- Trigger key function Signum® 2 and 3 only
- Trigger key function Signum® 2 and 3 only
- Combined zero/tare function
- Trigger key function
- Trigger key function
- Trigger key function Signum® 2 and 3 only
- Trigger key function Signum® 2 and 3 only
- Trigger key function Signum® 3 only

**External input 1**

- Trigger key function
- Trigger key function Signum® 3 only

**External input 2**

- Trigger key function
- Trigger key function Signum® 3 only

**External input 3**

- Trigger key function
- Trigger key function Signum® 3 only

**External input 4**

- Trigger key function
- Trigger key function Signum® 3 only

**External input 5**

- Trigger key function
- Trigger key function Signum® 3 only

**External output ports**

**External output 1**

- Weighing instrument ready to operate
- Weighing instrument stable
- Weighing instrument overflow ("H")
- Weighing instrument underflow ("L")
- Value in tare memory
- Below SQmin load
- Above SQmin load
- Lighter Signum® 2 and 3 only
- Equal Signum® 2 and 3 only
- Heavier Signum® 2 and 3 only
- Set Signum® 2 and 3 only

**External output 2**

- Weighing instrument ready to operate
- "
- Set

**External output 3**

- Weighing instrument ready to operate
- "
- Set

**External output 4**

- Weighing instrument ready to operate
- "
- Set

**External output 5**

- Weighing instrument ready to operate
- "
- Set

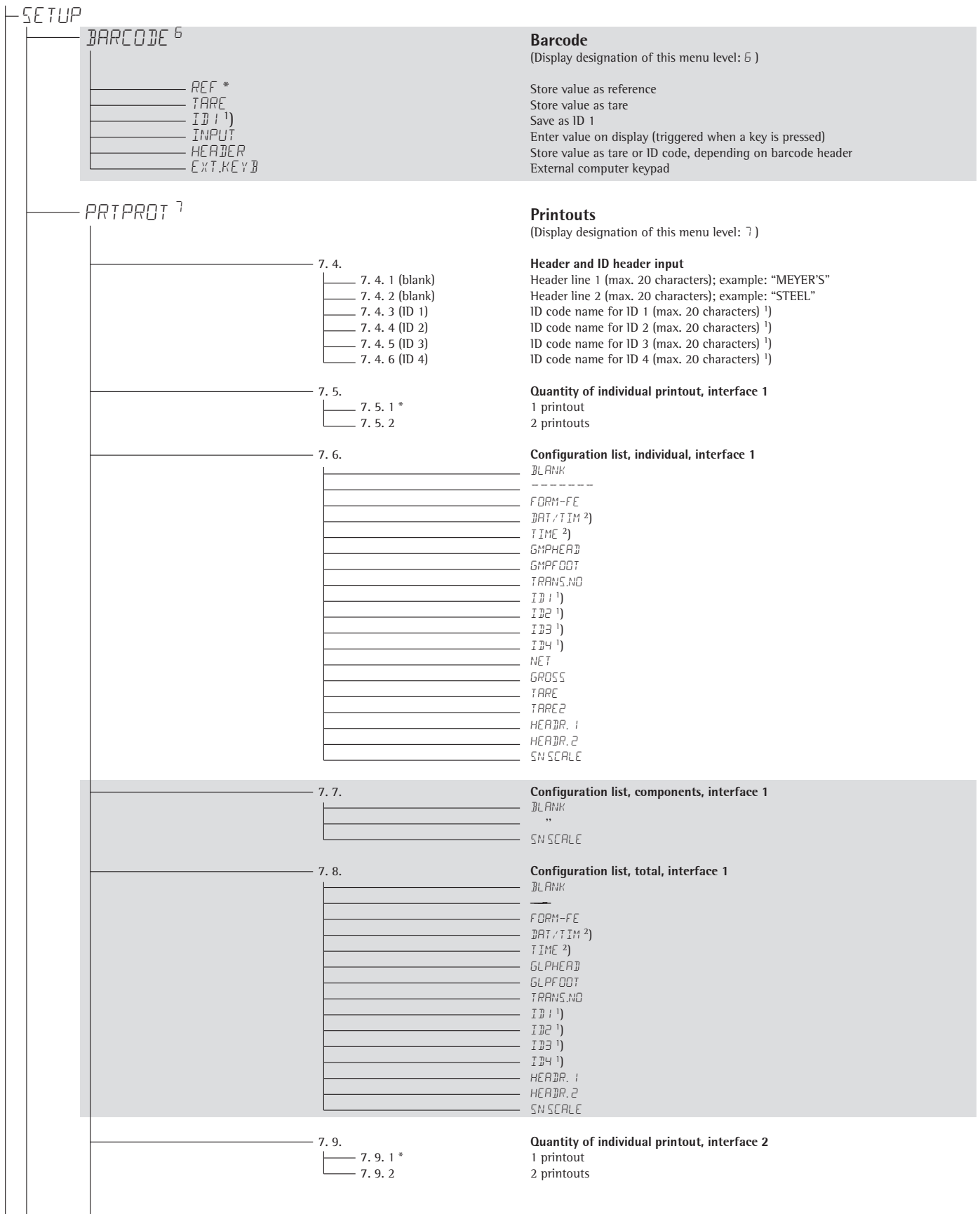

**Barcode**

(Display designation of this menu level: 6 )

- Store value as reference
- Store value as tare
- Save as ID 1
- Enter value on display (triggered when a key is pressed)
- Store value as tare or ID code, depending on barcode header
- External computer keypad

**Printouts**

(Display designation of this menu level: 7 )

**Header and ID header input**

- Header line 1 (max. 20 characters); example: "MEYER'S"
- Header line 2 (max. 20 characters); example: "STEEL"
- ID code name for ID 1 (max. 20 characters) <sup>1)</sup>
- ID code name for ID 2 (max. 20 characters) <sup>1)</sup>
- ID code name for ID 3 (max. 20 characters) <sup>1)</sup>
- ID code name for ID 4 (max. 20 characters) <sup>1)</sup>

**Quantity of individual printout, interface 1**

- 1 printout
- 2 printouts

**Configuration list, individual, interface 1**

- BLANK
- FORM-FE
- DAT/TIM <sup>2)</sup>
- TIME <sup>2)</sup>
- GLPHEAR
- GLPFOOT
- TRANS.NO
- ID 1 <sup>1)</sup>
- ID 2 <sup>1)</sup>
- ID 3 <sup>1)</sup>
- ID 4 <sup>1)</sup>
- NET
- GROSS
- TARE
- TARE2
- HEADR. 1
- HEADR. 2
- SN SCALE

**Configuration list, components, interface 1**

- BLANK
- SN SCALE

**Configuration list, total, interface 1**

- BLANK
- FORM-FE
- DAT/TIM <sup>2)</sup>
- TIME <sup>2)</sup>
- GLPHEAR
- GLPFOOT
- TRANS.NO
- ID 1 <sup>1)</sup>
- ID 2 <sup>1)</sup>
- ID 3 <sup>1)</sup>
- ID 4 <sup>1)</sup>
- HEADR. 1
- HEADR. 2
- SN SCALE

**Quantity of individual printout, interface 2**

- 1 printout
- 2 printouts

<sup>1)</sup> For Signum® 3 only

<sup>2)</sup> Only active when the device is equipped with a clock module

SETUP			
	PRTPROT <sup>1)</sup>		
	7.10.		Configuration list, individual, interface 2
		<input type="checkbox"/> BLANK	
		<input type="checkbox"/> -----	
		<input type="checkbox"/> FORM-FE	
		<input type="checkbox"/> DAT/TIM <sup>2)</sup>	
		<input type="checkbox"/> TIME <sup>2)</sup>	
		<input type="checkbox"/> GLPHEDD	
		<input type="checkbox"/> GLPFDDT	
		<input type="checkbox"/> TRANS.NO	
		<input type="checkbox"/> ID1 <sup>1)</sup>	
		<input type="checkbox"/> ID2 <sup>1)</sup>	
		<input type="checkbox"/> ID3 <sup>1)</sup>	
		<input type="checkbox"/> ID4 <sup>1)</sup>	
		<input type="checkbox"/> NET	
		<input type="checkbox"/> GROSS	
		<input type="checkbox"/> TARE	
		<input type="checkbox"/> TARE2	
		<input type="checkbox"/> HEADR. 1	
		<input type="checkbox"/> HEADR. 2	
		<input type="checkbox"/> SN SCALE	
	7.11.		Configuration list, components, interface 2
		<input type="checkbox"/> BLANK	
		<input type="checkbox"/> "	
		<input type="checkbox"/> SN SCALE	
	7.12.		Configuration list, total, interface 2
		<input type="checkbox"/> BLANK	
		<input type="checkbox"/> -----	
		<input type="checkbox"/> FORM-FE	
		<input type="checkbox"/> DAT/TIM <sup>2)</sup>	
		<input type="checkbox"/> TIME <sup>2)</sup>	
		<input type="checkbox"/> GLPHEDD	
		<input type="checkbox"/> GLPFDDT	
		<input type="checkbox"/> TRANS.NO	
		<input type="checkbox"/> ID1 <sup>1)</sup>	
		<input type="checkbox"/> ID2 <sup>1)</sup>	
		<input type="checkbox"/> ID3 <sup>1)</sup>	
		<input type="checkbox"/> ID4 <sup>1)</sup>	
		<input type="checkbox"/> HEADR. 1	
		<input type="checkbox"/> HEADR. 2	
		<input type="checkbox"/> SN SCALE	
	7.13.		<b>GMP-compliant printouts</b>
		<input type="checkbox"/> 7.13.1 *	Off
		<input type="checkbox"/> 7.13.3	On
	7.14.		<b>Date/Time <sup>2)</sup></b>
		<input type="checkbox"/> 7.14.1 *	Date/Time block with time
		<input type="checkbox"/> 7.14.2	Date/Time block without time
	7.15.		<b>Automatic print at stability</b>
		<input type="checkbox"/> 7.15.1 *	One-time auto print at stability off
		<input type="checkbox"/> 7.15.2	One-time auto print at stability on
	7.16.		<b>Flex print</b>
		<input type="checkbox"/> 7.16.1 *	OFF
		<input type="checkbox"/> 7.16.2	ON
	7.17.		<b>Decimal separator</b>
		<input type="checkbox"/> 7.17.1 *	Period
		<input type="checkbox"/> 7.17.2	Comma
	7.18.		<b>Printout of Alibi and product data memory</b>
		<input type="checkbox"/> 7.18.1.1 *	Print all data records
		<input type="checkbox"/> 7.18.1.2	Print the number of data records selected under 7.18.2
		<input type="checkbox"/> 7.18.2	Number selection: 1* to 255
	9.1.		<b>Restore factory settings in numeric menu for printout data protocol</b>
		<input type="checkbox"/> 9.1.1	Yes
		<input type="checkbox"/> 9.1.2 *	No

<sup>1)</sup> Only for Signum® 3

<sup>2)</sup> Only active when the device is equipped with a clock module

<pre> SETUP ├── UTILIT <sup>⊖</sup> │   ├── 8. 3. │   │   ├── 8.3.1 * │   │   ├── 8.3.2 │   │   ├── 8.3.3 │   │   ├── 8.3.4 │   │   ├── 8.3.5 │   │   ├── 8.3.6 │   │   ├── 8.3.7 │   │   ├── 8.3.8 │   │   ├── 8.3.9 │   │   ├── 8.3.10 │   │   ├── 8.3.11 │   │   ├── 8.3.12 │   │   ├── 8.3.13 │   │   ├── 8.3.14 │   │   ├── 8.3.15 │   │   ├── 8.3.16 │   │   ├── 8.3.17 │   │   ├── 8.3.18 │   │   └── 8.3.19 │   ├── 8. 7. │   │   ├── 8.7.1 │   │   └── 8.7.2 * │   ├── 8. 8. │   │   ├── 8.8.1 * │   │   ├── 8.8.2 │   │   └── 8.8.3 │   ├── 8.9. │   │   ├── 8.9.1 * │   │   ├── 8.9.2 │   │   └── 8.9.3 │   ├── 8.11. │   │   ├── 8.11.1 * │   │   └── 8.11.2 │   ├── 8.12. │   │   ├── 8.12.1 * │   │   └── 8.12.2 │   └── 9.1. │       ├── 9.1.1 │       └── 9.1.2 * </pre>	<p><b>Operation</b> (Display designation of this menu level: ⊖)</p> <p><b>Keypad</b> All available All blocked Numeric keypad                    Signum<sup>⊖</sup> 3 only Toggle weighing platform        Signum<sup>⊖</sup> 2 and 3 only Zero Tare FN isoTEST Print x10                                    Signum<sup>⊖</sup> 2 and 3 only Toggle gross/net                  Signum<sup>⊖</sup> 2 and 3 only CF                                    Signum<sup>⊖</sup> 2 and 3 only Ref                                   Signum<sup>⊖</sup> 2 and 3 only OK                                    Signum<sup>⊖</sup> 2 and 3 only Toggle                               Signum<sup>⊖</sup> 2 and 3 only Info                                  Signum<sup>⊖</sup> 2 and 3 only 'D'                                    Signum<sup>⊖</sup> 3 only ID                                    Signum<sup>⊖</sup> 3 only Mem                                   Signum<sup>⊖</sup> 3 only</p> <p><b>Automatic shutoff of display and control unit</b> Automatic shutoff acc. to menu item 8.9. No automatic shutoff</p> <p><b>Display lighting</b> On Off Automatic shutoff acc. to menu item 8.9</p> <p><b>Timer</b> After 1 + 1 minute not in use (after 1 min.: warning displayed <sup>2)</sup> for 1 minute) After 2 + 2 minutes not in use (after 2 min.: warning displayed <sup>2)</sup> for 2 minutes) After 5 + 5 minutes not in use (after 5 min.: warning displayed <sup>2)</sup> for 2 minutes)</p> <p><b>Main scale: first platform displayed on start-up</b> Weighing platform WP 1 Weighing platform WP 2</p> <p><b>Show geographical data before calibration/adjustment</b> No Yes</p> <p><b>Restore factory settings in numeric operating menu</b> Yes No</p>
--	--

<sup>1)</sup> Multiple selections possible

<sup>2)</sup> Warning information: symbol "⚠ 12" flashing (all simultaneously)



SETUP

TIME <sup>3)</sup>

**Time**

Format: e.g. 10.07.41 (hours.minutes.seconds)

DATE <sup>3)</sup>

**Date**

Format: 01.05.02 (day.month.year);  
U.S. mode: (month.day.year)

U-CODE

**User password**

Set, change and delete password here  
(max. 8 characters): e.g. 12345678

SOMIN <sup>9)</sup>

(SOMIN-5: For service only:  
Enter the min. sample quantity)

Display

No \*  
 Yes

Print in GLP header

No \*  
 Yes

INFO

SERVICE

**Device-specific information**

**Service information**

Service date

10.04.02 <sup>1)</sup>

**Indicator**

Model type  
Serial number  
Software version  
Application version  
Geographical latitude (in degrees) <sup>1)</sup>  
Geographical altitude (in meters) <sup>1)</sup>  
Acceleration of gravity m/s <sup>1)</sup>

TERM

SIWRJCP2 <sup>1)</sup>  
10405355 <sup>2)</sup>  
01.24.01 <sup>3)</sup>  
SI 202.050110 <sup>4)</sup>  
52 <sup>5)</sup>  
150 <sup>6)</sup>  
8.91 <sup>7)</sup>

WP-2

**Optional second weighing platform (e.g. IS weighing platform)**

Model: second weighing platform  
Software version: second weighing platform  
Serial number  
Geographical latitude (in degrees) <sup>1)</sup>  
Geographical altitude (in meters) <sup>1)</sup>  
Acceleration of gravity m/s <sup>1)</sup>

YCO01IS <sup>1)</sup>  
01.20.07 <sup>2)</sup>  
10404353 <sup>3)</sup>  
52 <sup>4)</sup>  
150 <sup>5)</sup>  
8.91 <sup>6)</sup>

FLEX-INF

**Flex print**

File name <sup>2)</sup>  
ID <sup>2)</sup>  
Version <sup>2)</sup>

APPLSET <sup>1)</sup>  
ID 123 2  
V 123 3

LANG.

**Language for adjustment and GMP printouts**

German  
English  
English with U.S. date/time  
French  
Italian  
Spanish

DEUTSCH  
ENGLISH\*  
U.S. MODE  
FRANC.  
ITAL.  
ESPAÑOL

<sup>1)</sup> Output: either latitude and altitude or acceleration of gravity (depends on the input before verification)  
<sup>2)</sup> These three parameters are shown for each file loaded.  
<sup>3)</sup> Only active when the device is equipped with a clock module.

## Operation

### Weighing

#### Weighing $\Delta\Delta$

The basic weighing function is always accessible and can be used alone or in combination with application programs, such as Counting, Checkweighing, Weighing in Percent, etc.

#### Characteristics

- Zeroing  $\rightarrow 0 \leftarrow$
- Store the weight on the platform as tare by pressing  $\rightarrow T \leftarrow$
- Use the numeric keys to enter a tare weight (press  $\rightarrow T \leftarrow$  to save)
  - Signum<sup>®</sup> 2 and 3 only:
    - Use a barcode scanner to enter tare weight
- Tare container weight automatically
- Delete tare values by entering  $\boxed{0}$  (press  $\rightarrow T \leftarrow$  to save)
- Press  $\boxed{Fn}$  to toggle between:
  - 1st and 2nd weight unit
  - Display value and min. sample quality "SQmin"
- Signum<sup>®</sup> 1 only:
  - Gross and net values
  - 10-fold increased resolution (display max. 5 seconds)
- Signum<sup>®</sup> 2 and 3 only:
  - Press  $\boxed{Fn}$  to toggle between:
    - 10-fold increased resolution (display max. 5 seconds)
  - Toggle  $\boxed{CF}$  Net:
    - Gross and net value
- You can configure the  $\boxed{Fn}$  key function in the Setup menu via:
 

*FNKEY*
- Weighing with two weighing platforms
  - Signum<sup>®</sup> 3 only:
    - Individual ID codes for weight values
  - Print weight values:
    - Manually, by pressing  $\boxed{E}$
    - Automatically (see Data Outputs)
    - GMP printout (see Data Outputs)
- Restore factory settings by selecting the menu setting:
 

*APPL*: (Application)  
*WEIGH*: (basic weighing)  
 9.1 (factory settings)
- Signum<sup>®</sup> 3 only:
 

*APPL*: *DEF.APP*: 9.1

### Automatic taring

The first weight on the scale that exceeds the preset minimum load is stored in the tare memory at stability.

The values for subsequent loads are stored as weight values. The scale returns to the initial state when the load is less than 50% of the minimum load. Configure in Setup under:

*APPL*: (Application)

*WEIGH*: (basic weighing)

3.7. (autotare first weigh)

For Signum<sup>®</sup> 3:

*APPL*: *A.TARE*

### Minimum load

To tare container weights automatically, you need to set a minimum load in the Setup menu, under:

*APPL*: (Application)

*WEIGH*: (basic weighing)

3.5. (Min. load for autotaring)

For Signum<sup>®</sup> 3:

*APPL*: *M.WEIGH*

10 setting levels are available for selection. They are defined in scale intervals:

- 1 digit (no minimum load)
- 2 digits
- 5 digits
- 10 digits
- 20 digits
- 50 digits
- 100 digits
- 200 digits
- 500 digits
- 1000 digits

Example: if the scale interval is 1 g and the minimum load is set to 1000 digits (=1000 scale intervals), a load of at least 1000 g is required for autotaring.

### Automatic printing

The first weight value that exceeds the minimum load is printed. Operating menu setting:

*APPL*: (Application)

*PRINTPRNT*: (Printout)

7.15. (Once at stability)

Signum<sup>®</sup> 2 and 3 only:

### Weighing with two weighing platforms

Press the  $\Delta\Delta$  key to toggle the display between weighing platforms. Specify one of the two platforms as the "main scale" under:

*APPL*: (Application)

*UTILITI*: (operation)

8.11. (Main scale)

The display shows the readout from the main scale when you switch on the device. Press  $\Delta\Delta$  to toggle the readout between platforms.

### Signum<sup>®</sup> 2 and 3 only: Using a barcode scanner to enter tare weight

The tare weight of the container can be entered via a barcode scanner. To do this, the "Store value as tare (TARE) menu item must be activated in the operating menu under Setup, Barcode. The value is applied and saved automatically, the  $\boxed{Tare}$  key does not have to be pressed. The content of the tare memory can be displayed in Info mode ( $\boxed{Info}$  key).

## Device parameters

### Keypad

The keypad can be blocked.

Operating menu setting:

*SETUP*:

*UTILITI*: (Operating parameter)

8.3. (Keypad: blocking keys)

The following settings are available:

- 8.3.1. (All keys available)
- 8.3.2. (All keys blocked except  $\boxed{Info}$  and  $\boxed{SETUP}$ )
- 8.3.3. (All alphanumeric keys blocked)
- 8.3.4 - 8.3.19 (Specified keys blocked (see the menu under "Configuration" for options))

### Display

You can have the display backlighting shut off automatically when not in use.

Operating menu setting:

*SETUP*:

*UTILITI*:

8.8. (Display lighting)

### Automatic shutdown

Operating menu setting:

*SETUP*:

*UTILITI*:

8.7. (Automatic shutoff of indicator)

### Timer

There are three timer settings: two, four or ten minutes:

*SETUP*:

*UTILITI*:

8.9. (Timer)

**Example with Signum® 1:**

Switch on the device, zero the scale, tare the container weight, place sample in the container, toggle display to gross weight or to second weight unit or 10-fold resolution, print results.



1.) Switch on the scale

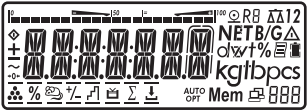

All display elements appear for approx. 1 second (display check)



Display with tared scale and filled container



Display with no load on scale

Signum® 1: **Fn**

6.) Toggle display; depending on configuration, display shows



2.) Zero the scale

Signum® 2 and 3: **CF**

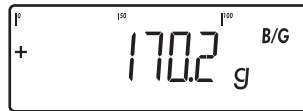

the gross weight (in this example, 50 g for container + 120.2 g substrate)



Display with no load on scale

**Fn**

or



display in 2nd weight unit (in this example kg)

or

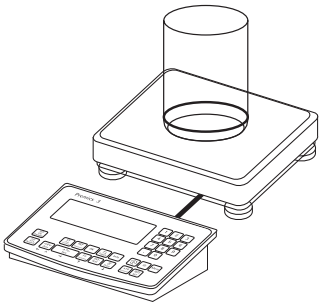

3.) Place container on weighing platform

Signum® 1: **Fn**

Signum® 2 and 3: **F1**

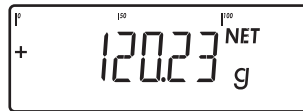

Display in 10-fold higher resolution



Container weight is displayed



7.) Return to previous display (if 10-fold resolution is shown, display returns automatically after 5 seconds)



4.) Tare the scale



8.) Print results



Display (NET) when tared with container

ACE HARDWARE  
Bovenden  
24.02.2017 15:10

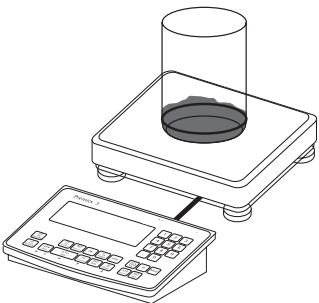

5.) Fill the container (in this example 120.2 g).

G# + 170.2 g  
T + 50.0 g  
N + 120.2 g

**Example with Signum® 1:**

Tare the scale by placing a container on the weighing platform



- 1.) Switch on the scale.  
The automatic self-test runs. When the weight readout is shown, the scale is ready to operate and automatically set to zero. With no load on the platform, you can zero the weighing platform at any time by pressing  $\rightarrow 0 \leftarrow$ .

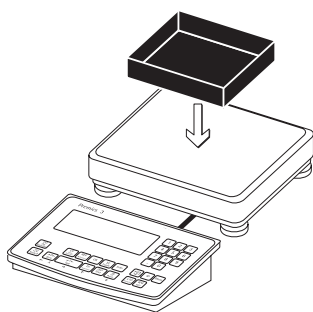

- 2.) Place empty container on the platform.



- 3.) Tare the scale.  
Note: If the automatic tare function is enabled, you do not need to press the  $\rightarrow T \leftarrow$  key. The tare weight is saved automatically when you place the container on the platform.

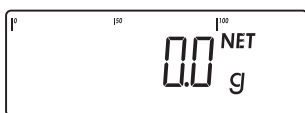

Wait until a zero value is displayed together with the NET symbol (net weight).

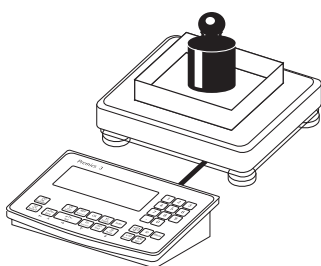

- 4.) Place sample on the platform

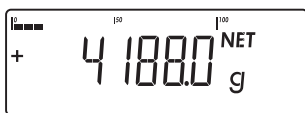

Wait until the weight unit symbol is displayed (indicating stability) and then read off the weight value

**Example with Signum® 3:**

Numeric input of tare weight, print the results



- 1.) Switch on the scale.  
The automatic self-test runs. When the weight readout is shown, the scale is ready to operate and automatically set to zero. With no load on the platform, you can zero the weighing platform at any time by pressing  $\rightarrow 0 \leftarrow$ .

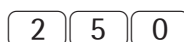

- 2.) Enter the tare weight in the current weight unit using the keypad (in this example, 250 g).

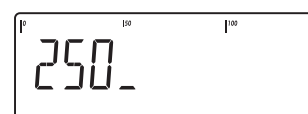

- 3.) Save the tare weight.

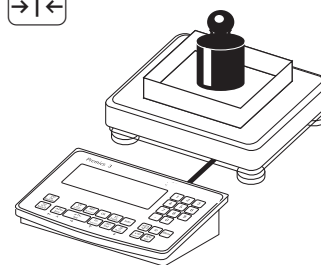

- 4.) Place the sample (in this example, 2 kg) in its container on the scale.

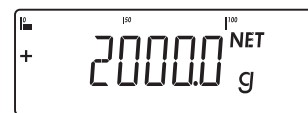

Read the result.



- 5.) Toggle the display from net to gross weight values.  
The display shows: the gross weight (in this example, 250 g for the container plus 2000 g for the sample)

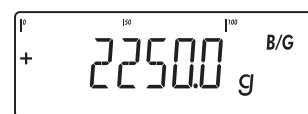

- 6.) Toggle to the previous display.

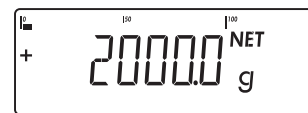

- 7.) Print the results.

G#	+	2.250	kg
T	+	0.000	kg
PT2	+	0.250	kg
N	+	2.000	kg

**Example with Signum® 3:**

Weighing with variable tare values, printing results, deleting tare values



- 1.) Switch on the scale.  
The automatic self-test runs. When the weight readout is shown, the scale is ready to operate and automatically set to zero. With no load on the weighing platform, you can zero the weighing platform at any time by pressing  $\rightarrow 0 \leftarrow$ .

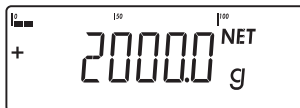

Read the net weight.

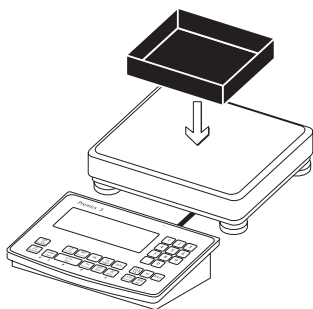

- 2.) Place empty container on the platform.



- 7.) Print the results.

G#	+	6.433	kg
T	+	4.183	kg
PT2	+	0.250	kg
N	+	2.000	kg



- 3.) Tare the scale  
Note: If the automatic tare function is enabled, you do not need to press the  $\rightarrow T \leftarrow$  key. The tare weight is saved automatically when you place the container on the platform.



- 8.) Clear the tare memory:  
Enter a zero ("0") using the keypad.



- 9.) Save the value (0) entered (tare values are cleared; the display shows the gross value).

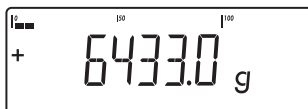

- 10.) Print the results.

G#	+	6.433	kg
T	+	0.000	kg
N	+	6.433	kg



Wait until a zero value is displayed together with the NET symbol (net weight).

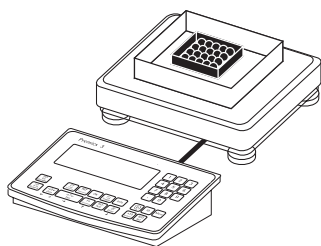

- 4.) Place packaged sample in the container (2nd tare value).

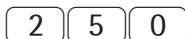

- 5.) Enter the tare weight of the packaging in the current weight unit using the keypad (in this example, 250 g).



- 6.) Save the package weight.  
The package tare is added to the container tare.

## Calibration and Adjustment

### Purpose

Perform calibration to determine the difference between the value displayed and the actual weight on the platform. Calibration does not entail making any changes within the weighing equipment.

During adjustment, the difference between the measured value displayed and the true weight of a sample is corrected, or is reduced to an allowable level within maximum permissible error limits.

### Configuration for Use in Legal Metrology

Configuration of the weighing instrument for use in legal metrology is set by a switch. The switch is located on the back of the weighing platform and covered by a protective cap.

### Using a verified scale in legal metrology in the EU:

The Type-Approval Certificate for verified scales is only valid for non-automatic weighing instruments. For automatic operation with or without additional, integrated equipment, please follow the applicable national regulations for the installation location.

- Before use in legal metrology, the scale should be calibrated via the internal calibration equipment at the installation location: see the "Internal Calibration" section in this chapter.
- The temperature range (°C) listed on the ID label should not be exceeded during operation.

For Servicing:

### External calibration for verified scales of accuracy class II and III

- External calibration is blocked in legal metrology (switch cover is sealed)
- External calibration only possible by removing the seal

If the seal is broken, the validity of verification will become void and you must have your scale re-verified.

### Using a verified scale in legal metrology with internal adjustment equipment:

- Before use in legal metrology, the "internal calibration" function should be carried out at the installation location.

## Switch

1 -> Service switch

Switch 1 should only be used for servicing.

2 -> Verification access switch

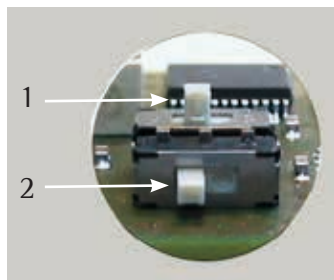

Position: right

- Switch 2 on the right -> for use in legal metrology

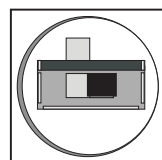

Position: left

- Switch 2 on the left -> external calibration/ adjustment accessible

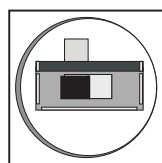

The function of switch 2 is reversed for SIWSBBS.

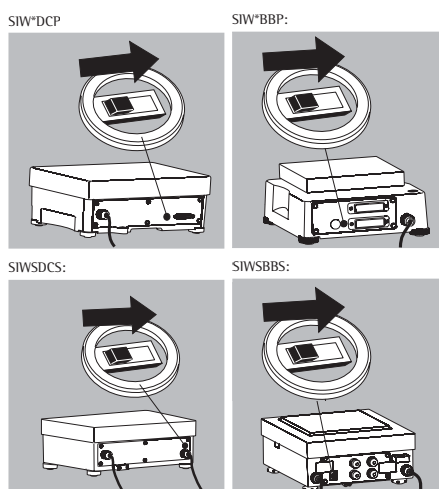

## Characteristics

Which of the following features are available depends on the connected weighing platform. These features are configured in the Setup menu:

- External calibration/adjustment blocked in verified weighing instruments
- External calibration/adjustment with the default weight value or standard weight (not available on verified instruments):  
 SETUP  
 WP- 1  
 I.9.: Calibration/Adjustment
- Specify the weight for external calibration/adjustment:  
 SETUP  
 WP- 1  
 I. 18.: (enter calibration weight)
- Internal adjustment for IS weighing platforms (configure under: COM 1: or UNICOM: WP2)
- Block the  $\square$  key to prevent the use of the two functions described above:  
 SETUP  
 WP- 1  
 I.9.: Calibration/Adjustment
- Calibrate first; then adjust automatically or manually (not on verified weighing instruments):  
 SETUP  
 WP- 1  
 I. 10.: (calibration/adjustment sequence)
- Flashing  $\Delta\Delta$  symbol as adjustment prompt. If more than one weighing platform is connected, the platform number is also displayed:  
 SETUP  
 WP- 1  
 I. 15.: (calibration prompt)
- Block external calibration/adjustment:  
 SETUP  
 WP- 1  
 I. 16.: (external calibration)

**SIWR, SIWA models:**

**Geographical data**

- Elevation and latitude or gravitational acceleration displayed after **CAL** is shown when the Signum is switched on, if these values are supported by the weighing encoder:

SETUP  
UTILIT

8. 12.: (show geographical data before calibration/adjustment)

For each of these parameters, the term is displayed first (**ALTI TUD**, **LATI TUD** or **GRAVITY**) for 1 second, and then the corresponding value is displayed continuously until you press **→T←**.

**Note**

When using verified weighing instruments, the external adjustment function can only be used when the menu access switch is open once the verification seal has been broken. The device must then be verified again.

**Internal calibration**

For SIWS models only:  
Verified versions or with option E7

In Setup (**SETUP: WP- 1: 1.9.**) the "internal calibration" option (**SETUP: WP- 1: 1.9.4**) must be set.

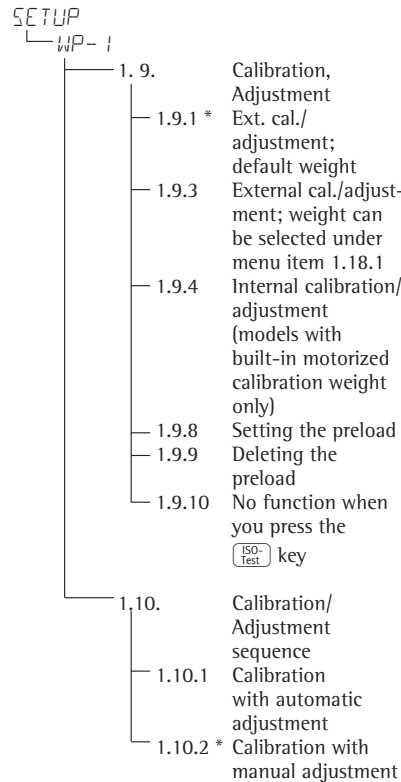

\* = Factory setting

The scale housing has a built-in motorized calibration weight.

The calibration/adjustment procedure is performed as follows:

- Select calibration/adjustment: Press the **ISO-Test** key
- > The internal calibration weight is loaded automatically
- > The scale is adjusted
- > If parameter 1.10.1 is selected in Setup (**SETUP: WP- 1: 1.10.**), the scale is adjusted automatically
- > If parameter 1.10.2 is selected in Setup (**SETUP: WP- 1: 1.10.**), the internal calibration can be stopped without adjusting the scale
- > The internal calibration weight is unloaded from the scale
- > ISO/GMP-compliant record: see page 91

**Setting the preload**

**Setup information**

- △ It is only possible to set a preload when the menu access switch is open.
- The **ISO-Test** key must be assigned the set preload function (menu item 1.9.8)
- △ After setting a preload, close the menu access switch and reallocate the original function back to the **ISO-Test** key (e.g. external calibration/adjustment with user-defined weights) under menu item 1.9.

**Deleting the preload**

**Setup information**

- △ It is only possible to clear a preload when the menu access switch is open.
- The **ISO-Test** key must be set to the clear preload function (menu item 1.9.9)
- △ After clearing the preload, close the menu access switch and reallocate the original function back to the **ISO-Test** key (e.g. external calibration/adjustment with user-defined weights) under menu item 1.9.

**Preparation**

- Switch on the scale: Press the **(ON)** key
- While all segments are lit, press the **(←T→)** key
- Select the Setup menu: Press the **(Fn)** key repeatedly until **SETUP** is displayed
- Open the Setup menu: Press the **(←T→)** key
- Select weighing platform 1 "WP 1:": Press the **(←T→)** key or
- Select interface 1 "COM-1" or interface 2 "UNICOM" (depending on the interface): Press the **(Fn)** key  
Select weighing platform 2 "WP2:": Press the **(←T→)** key

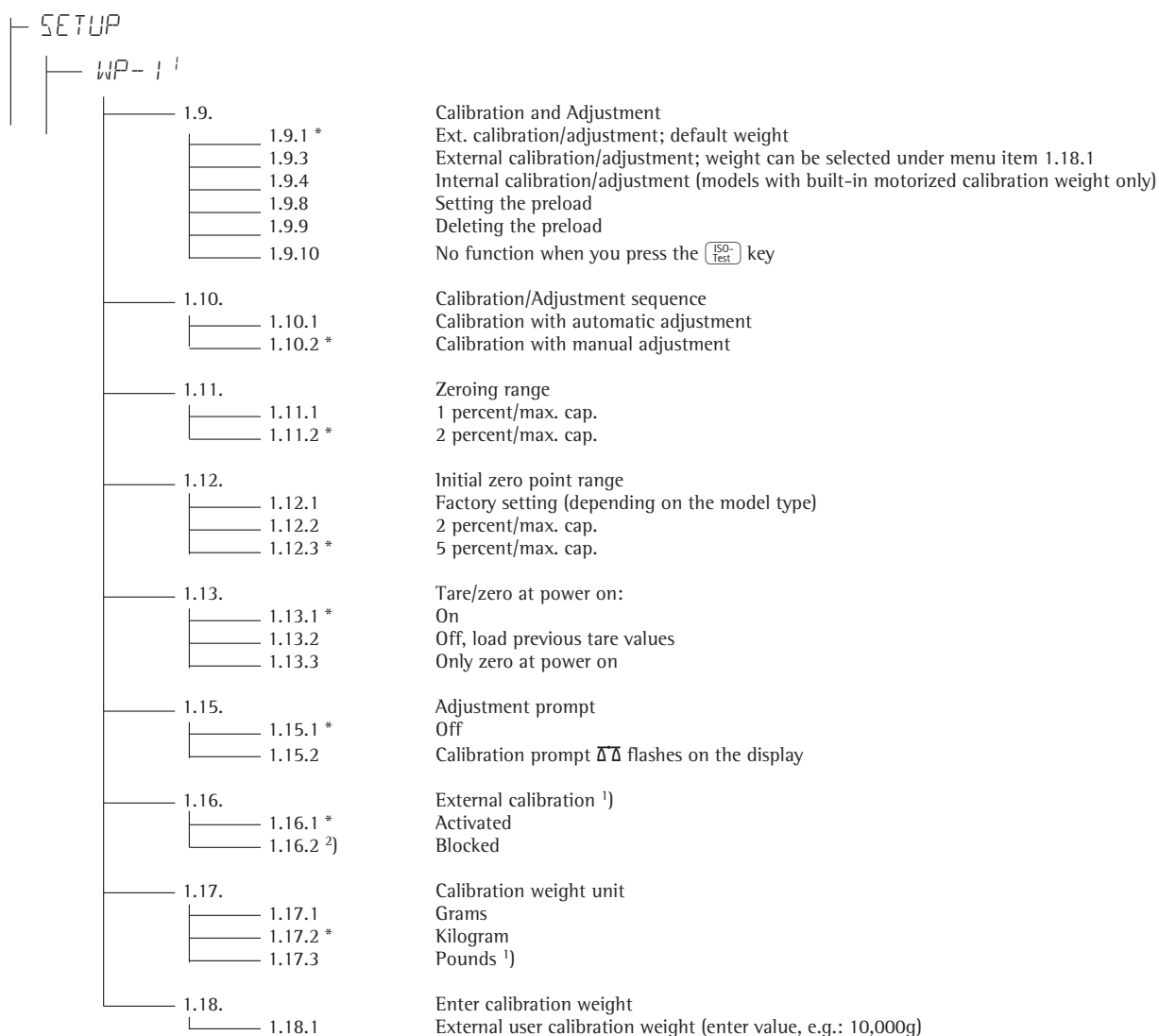

- Save settings with the **(←T→)** key and exit Setup by pressing the **(→0←)** key repeatedly)

<sup>1)</sup> = Not available on scales verified for use in legal metrology

<sup>2)</sup> = Factory setting for use in legal metrology

\* Factory settings



**Example:**

External calibration and manual adjustment with default weights (weighing parameters: factory settings)



1.) Zero the scale.

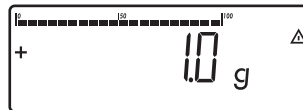
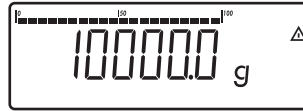

The difference between the measured value and the true weight of the sample will be displayed with plus/minus signs.



2.) Start calibration (e.g., when adjustment prompt flashes WP).

C.E.X.T.D.E.F appears for two seconds.

```
Ext.      calibration
Nom. +    10000 g
Diff. +    1 g
```

A printout will be generated if the process is cancelled using the  $\rightarrow 0 \leftarrow$  key.



You are prompted to place the required weight on the platform (e.g., 10,000 g).



4.) Activate calibration/adjustment (press the  $\rightarrow 0 \leftarrow$  key to cancel).

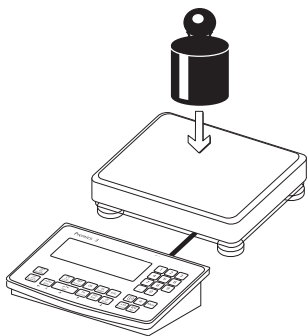

3.) Position the calibration/adjustment weight on the weighing platform.

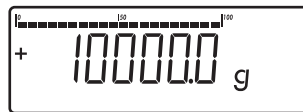

The adjustment weight is displayed once adjustment is complete.

```
-----
24.02.2017    10:15
TypSIWR
Ser.no.      12345678
Vers.        1.0103.11.2
BVers.       01-26-02
-----
Ext.      calibration
Nom. +    10000 g
Diff. +    1 g
Ext.      adjustment
Diff. +    0 g
-----
24.02.2017    10:15
Name:
-----
```

A GMP-compliant printout is generated.

## SQmin Function

### Purpose

To display the allowable minimum sample quantity "SQmin" (sample quantity minimum) in accordance with the United States Pharmacopoeia (USP). According to USP guidelines, the uncertainty of measurement may not exceed 0.1 % of the sample quantity when substances are weighed with the highest degree of accuracy for volume determination. This additional function ensures that weighing results lie within defined tolerance limits corresponding to the requirements of your quality assurance system.

### Requirements

The scale must be set up by a service technician to be able to use the SQmin function. The technician will determine the permitted minimum sample quantity and load this to your scale using the guidelines of your QA system. These settings cannot be changed by the user. He will document this setting via a "Weighing module test as per USP" certificate in which the measurements and min. sample quantity are logged. The SQmin function ensures that the weighing results correspond to USP guidelines.

### Characteristics

- Displaying the minimum sample quantity:  
The value is shown in the text line for 4 seconds after the **[Fn]** key is pressed.
- If the minimum sample quantity has not been reached:  
Symbol displayed: The **⚠** symbol is displayed and weight values are marked with a "!" in the printout.
- GLP header: The minimum sample quantity entered for SQmin can be included on the printout.

### Parameter Factory Settings

Display: SQmin Off

Print in GLP header: OFF

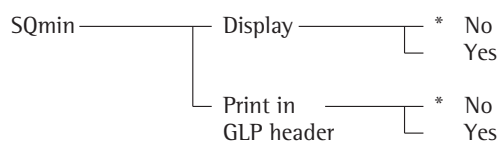

\* = Factory setting

See also the chapter on "Configuration: Application Parameters (Overview)"









- Save the settings with the **[→T←]** key and exit Setup: Press the **[→0←]** key several times.

**Example**

Determining sample weights while monitoring the minimum sample quantity (in this example, SQmin = 100 g)

Settings (different from the factory settings):

Setup: Equipment:  
 SQmin: Display: on

Step	Press key (or action)	Display/Printout
1. Switch on the scale and enter settings as above		
2. Place the container for the sample on the scale and tare		
3. Measure the weight of a sample (in this example: minimum sample quantity not reached)	Place the sample on the scale	
4. Print weight value		N + 90.0 !
5. Measure the weight of another sample (in this example: minimum sample quantity exceeded)	Place the sample on the scale	
6. Print weight value		N + 110.0 g
7. Display value of minimum sample quantity for 4 seconds		
8. Weigh other samples as desired		

## Individual ID codes (identifiers)

Signum® 3 only:

You can assign codes (such as product name, batch number, etc.) for identification of measured values on printouts.

### Factory settings for the ID code names

ID1: *ID1*  
 ID2: *ID2*  
 ID3: *ID3*  
 ID4: *ID4*

### Factory settings for the ID code values













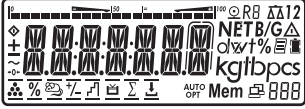

No default values set.



### Characteristics









- Assign up to four ID codes.
- Assign both a name and a value to each ID code.
- Displaying individual IDs: **ID** key
- The name is left-justified and the value is right-justified on the printout. If the entire code is too long for one line, additional lines are printed.
- Enter ID code names in Setup under:  
*SETUP: PRTPROT: 7.4.*  
 The name can have a max. of 20 characters. No more than 11 characters are displayed during input; all 20 characters are printed.
- Enter up to 40 characters for the value of the ID code. Press the **ID** key to activate the input mode.
- Individual characters of the ID can be deleted using the **CF** key.
- If both the name and value fields are empty, no ID code is printed.
- In the Setup program, you can configure when and whether ID codes are printed (see Configuring Printouts page 81).

**Example with Signum® 3:**

Enter ID code names.  
 “Batch number” and “Customer” should be entered for ID 1 and ID 2.

- 1) Switch on the scale  

- 2) While all segments are lit, press the  key  
  
 The first item in the Main menu is shown: *APPL*
- 3) Select the *SETUP* menu item for the ID code settings (press  repeatedly until *SETUP* is displayed)  
  

- 4) Select the Setup menu  
  

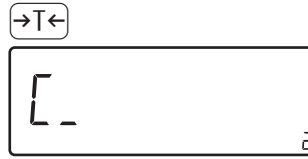
- 5) Select the *PRTPROT* menu item for the ID code settings (press  repeatedly until *PRTPROT* is displayed)
- 6) Select level 7.  
  

- 7) Press the  key until 7.4.1 appears in the display.  
  

  - Select the 7.4.3 ID1 name menu item (press the key until *PRTPROT* appears in the display)  
  



- 8) Press the  key to enable alphanumeric input.  
  

- 9) Enter the first character using the , , ,  keys (in this example: *⌈* is displayed)  
  



10) Save the character



11) Enter additional letters as described above.

After entering the last letter, save the input by pressing the  key



- Open the 7.4.4 ID2 name menu item
- Repeat starting with step 8



12) Exit this menu level and configure other settings as desired, or

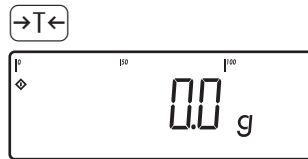

13) Press and hold to exit the menu

**Example with Signum® 3:**

Enter ID code values.  
 The value “123” should be entered for ID code 1.

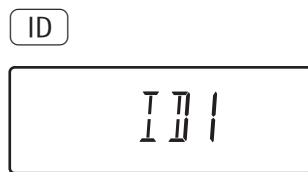
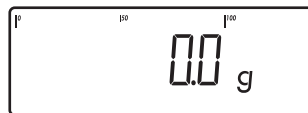

1) Activate input of ID code values.

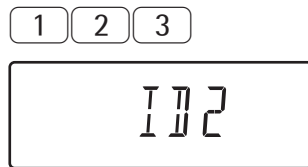

2) Enter the value for ID code 1 (in this example: *123*).



5) Exit after ID4 using the  key

# Application Programs

## Applications 1 - 3: Overview

	Signum® 1	Signum® 2	Signum® 3
Keys	6 keys	14 keys	17 keys plus numeric keypad
Display	14-segment	14-segment plus application symbols	14-segment plus application symbols

### Application

Basic weighing	X	X	X
Averaging (animal weighing)	-	X	X
Send print job/data record to peripheral device	X	X	X
Print labels	X	X	X
Connection option for second scale	-	X	X
Counting	-	X	X
Totalizing	-	X	X
Checkweighing	-	X	X
Batching/Counting to target value	-	X	X
Product data memory	-	-	X

### Function

Zero key	X	X	X
Taring	X	X	X
Date/Time	-	X	X
Internal battery (rechargeable)	Optional	Optional	Optional
ID codes (4 codes, 40 characters each)	-	-	X
Barcode	-	Optional	Optional

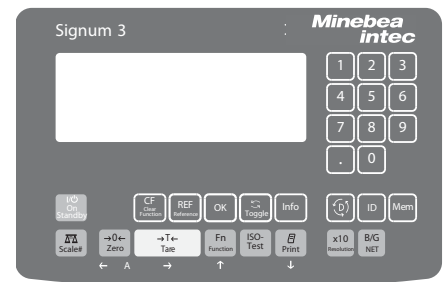
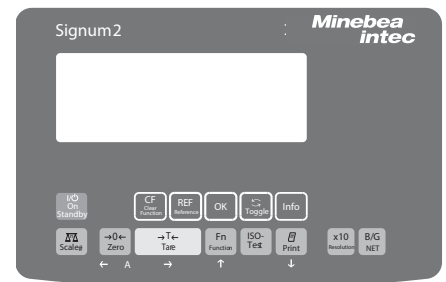
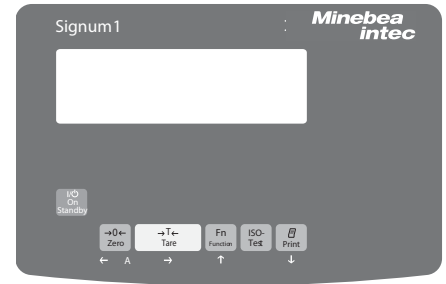

### Signum® 3 only:

The following table shows how the application programs can be combined.

Each row represents one combination. The basic weighing function is available at all times; it does not need to be combined with a computational function.





Select programs one after the other: Toggle using the  key

Application 1 (Basic Function)	Application 2 (Monitoring Function)	Application 3 (Cumulative-value Function)
Counting	-	Totalizing
Counting	Checkweighing	Totalizing
Counting	Checkweighing	-
Counting	Classification	-
Neutral measurement	-	Totalizing
Neutral measurement	Checkweighing	Totalizing
Neutral measurement	Checkweighing	-
Neutral measurement	Classification	-
Animal weighing	-	Totalizing
Animal weighing	Checkweighing	Totalizing
Animal weighing	Checkweighing	-
Animal weighing	Classification	-
Weighing in percent	-	Totalizing
Weighing in percent	Checkweighing	Totalizing
Weighing in percent	Checkweighing	-
Weighing in percent	Classification	-
-	-	Net-total formulation
-	Checkweighing	Totalizing



## Counting Application



With the Counting application, you can determine the number of parts which each have approximately equal weight.

### Characteristics





- Save the reference weight “wRef” from the weighing platform
- Signum® 3 only:
  - Enter the average piece weight “wRef” via the keypad
- Signum® 3 only:
  - Enter the reference sample quantity “nRef” via the keypad
- Enter reference sample weight using a barcode scanner
- Automatic reference sample updating
- Counting with two weighing platforms
- Activate Info mode via the  key
- Toggle the display between quantity and weight via the  key
- Define the level of accuracy (display resolution) applied when a calculated reference sample quantity is saved
- Automatic taring of container weight. Configured in Setup under:  
*APPL:  3.7.*  
 (autotare first weigh)  
 Signum® 3:  
*APPL: A.TARE*
- Automatic initialization when the scale is switched on. The indicator is initialized with the most recently used values for reference sample quantity “nRef” and reference sample weight “wRef.” Configured in Setup under:  
*APPL:  3.8.*  
 (Start App. with last values)  
 Signum® 3:  
*APPL: A.START*
- Exit application, delete parameters:  
 The value of the reference sample weight in the reference memory remains active until the application is changed or the value is overwritten or deleted via the  key. The reference sample weight also remains saved after the scale is turned off.

Signum® 3 only:

You can assign different functions to the  key for deleting applications. When you clear applications, you can delete either the data stored for all applications or just the data stored for the active application. Configured in Setup under:  
*APPL: SEL.CF.*  
 (sel. *CF* function key  in applications)







- Tare function:
  - 1) If you store a tare (weight value) by pressing the  key, you can later enter a value manually. The value you enter is added to the stored tare value. Setting: menu code 3.25.1 (factory setting)
  - 2) A value entered manually overwrites a stored tare value (weight value). If you enter a value manually, a tare value (weight value) stored later overwrites the manually entered value. Setting: menu code 3.25.2
 Configured in Setup under:  
 Signum® 2  
*APPL:  NM: 3.25.;*  
 Signum® 3  
*APPL: TARE.F: 3.25.*
- Restore factory default settings. Configured in Setup under:  
*APPL:  9.1.*  
 Signum® 3:  
*APPL: DEF.APP: 9.1.*

**Before the quantity on the platform can be calculated, the average piece weight (reference sample weight) must be entered in the application. There are three ways to enter this value in the program:**

- Calculation:
  - Place the number of parts defined as the reference sample quantity on the weighing platform and calculate the average piece weight by pressing the  key.
  - Alternatively, using the  key, you can place any number of parts on the weighing platform, enter the number of parts using the keypad, and then press the  key.
 How the reference weight is calculated depends on the application setting for resolution. The value is either rounded off in accordance with the display resolution, or saved with 10-fold or 100-fold resolution, or with the maximum internal resolution of the weighing platform.
- Signum® 3 only:
  - Enter a reference sample weight (i.e., the weight of one piece) using the keypad and saving it with the  key.
  - Enter the reference sample weight using a barcode scanner.

After initialization, you can use the connected weighing platform to count parts. The initial application values remain active until deleted by pressing the  key or until overwritten by a new value. They remain saved after the scales are switched off.



**Preparation**

- Switch on the scale: Press the  key
- While all segments are lit, press the  key
- Select the Setup menu: Press the  key repeatedly until *APPL* is displayed
- Confirm *APPL*: Press the  key
- Select the Counting application: Press the  key repeatedly and confirm with the  key

## Counting application parameters

— 3.6.	Minimum load for initialization
— 3.6.1*	1 digit
— 3.6.2	2 digits
— 3.6.3	5 digits
— 3.6.4	10 digits
— 3.6.5	20 digits
— 3.6.6	50 digits
— 3.6.7	100 digits
— 3.6.8	200 digits
— 3.6.9	500 digits
— 3.6.10	1000 digits
— 3.9.	Resolution for calculation of reference value
— 3.9.1*	Display accuracy
— 3.9.2	Display accuracy +1 decimal place
— 3.9.3	Display accuracy +2 decimal places
— 3.9.4	Internal resolution
— 3.11	Parameter for saving weight values
— 3.11.1*	With stability
— 3.11.2	With increased stability
— 3.12.	Average piece weight updating
— 3.12.1	Off
— 3.12.3*	Automatic
— 3.13.	Reference weighing instrument
— 3.13.1*	No weighing platform selected
— 3.13.2	Weighing platform WP 1
— 3.13.3	Weighing platform WP 2

\* = Factory setting

- Save the settings with the  key and exit Setup: Press the  key several times.

**Parameter for saving weight values**

The weight on the platform is saved as a reference value when the platform has stabilized. “Stability” is defined as the point at which the fluctuation of a measured value lies within a defined tolerance range. The narrower the tolerance range, the more stable the platform is at “stability”.

In Setup, under:

*APPL*:  3.11.

Signum® 3:

*APPL 1: COUNT*: 3.11.

You can define whether the value is saved when “standard stability” is reached, or only at “increased stability” (narrower tolerance range). If you select “increased stability,” the value saved for average piece weight will be more accurate and the results more reproducible, but the response time of the weighing platform might be longer.

**Accuracy of Average Piece Weight Calculation**

The resolution applied for calculating the reference weight is defined in Setup under:

*APPL*:  3.9.

Signum® 3:

*APPL 1: COUNT*: 3.9.

The resolution for calculating the reference weight is increased if “+1 decimal place,” “+2 decimal places” or “Internal resolution” is selected. With the “+1 decimal place” setting, the net value is determined to one additional decimal place (i.e., display accuracy × 10); “+2 decimal places” increases display accuracy + 100, and “Internal resolution” uses the maximum resolution available.

**Minimum load**

The minimum load required for initialization of the weighing platform is configured in Setup under:

*APPL*:  3.6.

Signum® 3:

*APPL 1: COUNT*: 3.6.

Once the limit is exceeded by the load, initialization can begin.

If the load on platform is too light, the following will occur when you try to save a value:

- The error code *INF 29* is displayed
- The weighing platform is not initialized
- The preset reference sample quantity is saved

The minimum load required for automatic taring of the container weight on the platform (first weight) is configured in Setup under:

*APPL*:  3.5.

Signum® 3:

*APPL 1: M.WEIGH*: 3.5.

You can choose from the following 10 levels for this setting:

- 1 digit
- 2 digits
- 5 digits
- 10 digits
- 20 digits
- 50 digits
- 100 digits
- 200 digits
- 500 digits
- 1000 digits

The “digits” here refer to the scale intervals in the connected weighing platform. If the interval of the connected platform is 1 g, for example, and 1000 digits are required, you must place at least 1000 g (= 1000 intervals = 1000 digits) on the weighing platform for initialization.



### Average piece weight updating

In Setup, under:

APPL:  3. 12.

Signum® 3:

APPL 1: COUNT: 3. 12.

You can define whether or not the reference sample weight is updated automatically during weighing.

The average piece weight is updated automatically only when the following 6 criteria are met:

1. The menu item must be set to 3. 12.3 in Setup.
2. The current piece count exceeds the original piece count by at least two.
3. The current piece count is less than twice the original piece count (does not apply for the first updating operation if the piece count is entered using the keypad or a barcode scanner).
4. The current piece count is less than 1000.

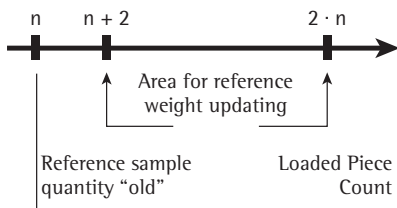

5. The internally calculated piece count (such as 17.24 pcs) differs by less than ± 0.3 pcs from the nearest whole number (in this example: 17).
6. The weighing platform is stable in accordance with the parameter defined for saving weights.

If automatic average piece weight updating is selected in the Setup menu and the piece count (pcs) is displayed, the *AUTO* symbol is displayed below the bar graph. If the reference sample weight has been updated since you began weighing, the text lines show the “optimized” code (*OPT.*). During an updating operation, *OPT* and the updated piece count are displayed briefly in the measured value line.

The new reference sample weight and reference sample quantity are saved.

### Counting with two weighing platforms

You can use two weighing platforms simultaneously with the Counting application. When using two platforms, you can choose from the following operating modes:

- Counting with two platforms of the same type
- Counting with one reference platform and one weighing platform

Counting with two platforms of the same type:

Use this mode to count different types of sample material with different weights. For example, count the lighter-weight pieces on one platform and the heavier pieces on another.

You can define one of the two platforms as the default scale.

This is configured in Setup, under:

SETUP:

UTILIT:

B. 11.: (main scale)

This is the first platform active when you switch on the Signum, regardless of the setting for automatic initialization of the Counting application.

### Counting with One Reference Platform and One Weighing Platform:

In this operating mode, the reference platform is a high-resolution weighing platform with a relatively low maximum capacity. The other platform is used for weighing heavier samples, and has a high capacity with a relatively low resolution.

This allows you to both determine the reference sample weight with high resolution; i.e., very precisely, and to count large amounts of parts, without requiring an expensive high-resolution, high-capacity weighing platform.

The system can be configured to switch automatically to the reference platform for initialization (the measured value line shows *REF*). Following initialization, you can switch to the counting platform.

The definition of one weighing platform as a reference platform is configured in Setup, under:

APPL:  3. 13.

Signum® 3:

APPL 1: COUNT: 3. 13.

If automatic reference sample updating is enabled, the update is performed on the active platform; in other words, the system does not automatically switch to the reference platform.

**Example:**

Determining the number of uncounted parts.

Settings (different from the factory settings):

Setup: Application 1: Counting

Setup: Device Parameters: Printout: PRTPROT: 7.6,

then select the menu line items of your choice (see “Configuration” for options)

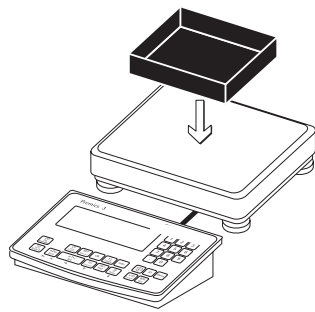

1.) Place empty container on the platform



2.) Tare the scale  
 Note: If the automatic tare function is enabled, you do not need to press the key to tare the platform; the tare weight is saved automatically when you place the container on the platform.

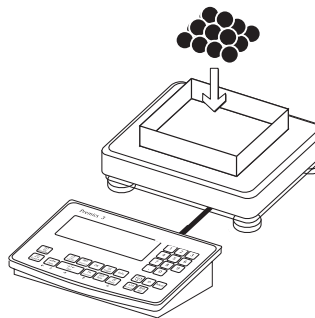

3.) Place a number of parts in the container for the reference quantity (in this example, 20 pcs)

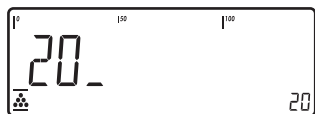

4.) Signum® 3 only:  
 Enter the number of parts using the keypad.



5.) Start calculation of the reference sample weight

Signum® 2:  
 Set the number of reference parts using (REF): 1, 2, 5, 10, 20, etc.  
 Start the reference sample weight calculation using the key.

If the weight is too light, reduce the minimum load setting or increase the reference sample quantity setting in the main display *INF 29* and the number of parts in the container.

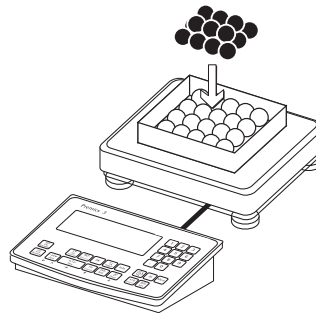

6.) Add a quantity of uncounted parts to the container

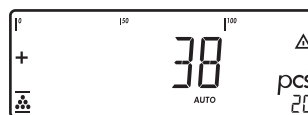

Read the result

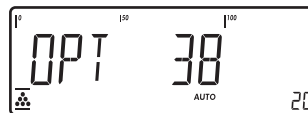

*OPT* is displayed if automatic reference sample updating is enabled



7.) Print the results

nRef	+	38	pcs
wRef	+	0.003280	kg
G#	+	0.373	kg
T	+	0.248	kg
N	+	0.125	kg

Configured printout:  
 see page 81







Qnt	38	pcs
-----		





## Neutral Measurement

### Application NM

With this application you, can use your weighing platform to measure the length, surface and volume of parts. The  symbol is displayed as the weight unit.

#### Characteristics

- Save the reference weight “wRef” from the weighing platform  
 Signum® 3 only:  
 Enter the reference weight “wRef” through the keypad
- Signum® 3 only:  
 Enter the factor for calculation “nRef” using the keypad
- Enter reference sample weight using a barcode scanner
- Measure with two weighing platforms
- Activate Info mode via the  key
- Toggle the display between measurement and weight via the  key
- Define the level of accuracy (display resolution) applied when a calculated reference weight is saved
- Automatic taring of container weight. Configured in Setup under:  
 APPL:  NM: 3.7.  
 (autotare first weigh)  
 Signum® 3:  
 APPL: A.TARE: 3.7.
- Automatic initialization when the scale is switched on. The indicator is initialized with the most recently used calculation factor “nRef” and reference weight “wRef.” Configured in Setup under:  
 APPL:  NM: 3.8.  
 (Start App. with last values)  
 Signum® 3:  
 APPL: A.START: 3.8.
- Exit application, delete parameters:  
 The value of the reference sample weight in the reference memory remains active until the application is changed or the value is overwritten or deleted via the  key. The reference sample weight also remains saved after the scale is turned off.  
 Signum® 3 only:  
 You can assign different functions to the  key for deleting applications. When you clear applications, you can delete either the data stored for all applications or just the data stored for the active application. Configured in Setup under:  
 APPL: SEL.CF: 3.24.  
 (Sel. CF function key  in applications)







- Tare function:  
 1) If you store a tare (weight value) by pressing the  key, you can later enter a value manually. The value you enter is added to the stored tare value. Setting: menu code 3.25.1 (factory setting)  
 2) A value entered manually overwrites a stored tare value (weight value). If you enter a value manually, a tare value (weight value) stored later overwrites the manually entered value. Setting: menu code 3.25.2  
 Configured in Setup under:  
 Signum® 2:  
 APPL:  NM: 3.25. ;  
 Signum® 3:  
 APPL: TARE.F: 3.25.
- Restore factory default settings.  
 Configured in Setup under:  
 APPL:  NM: 9.9. 1.  
 Signum® 3:  
 APPL: DEF.APP: 9. 1.  
 In order to calculate the length, surface or volume of a given sample, the average weight of a reference quantity of the sample must be known (in the example below, the reference is 1 meter of electrical cable). There are three ways to enter the reference weight in the program:
- Calculation:  
 - Place the reference quantity (defined by the calculation factor) on the connected weighing platform and calculate the reference sample weight by pressing the  key.  
 - Place any amount of the sample material on the connected weighing platform, enter the calculation factor through the keypad, and press the  key to calculate the reference sample weight.

How the reference weight is calculated depends on the application setting for resolution. The value is either rounded off in accordance with the display resolution, or saved with 10-fold or 100-fold resolution, or with the maximum internal resolution of the weighing platform.

- Keypad input: Enter the reference weight (i.e., the weight of one meter of electrical cable) using the keypad and press  to save it.
- Use a barcode scanner

The initial application values remain active until deleted by pressing the  key or until overwritten by a new value. They remain saved after the scale is switched off.



#### Preparation

- Switch on the scale: Press the  key
- While all segments are lit, press the  key
- Select the Setup menu: Press the  key repeatedly until APPL is displayed
- Confirm APPL: Press the  key
- Select the Neutral Measurement application:  
 Press the  key repeatedly and confirm with the  key

#### Neutral Measurement Application Parameters

3.6.	Minimum load for initialization	
3.6.1*	1 digit	
3.6.2	2 digits	
3.6.3	5 digits	
3.6.4	10 digits	
3.6.5	20 digits	
3.6.6	50 digits	
3.6.7	100 digits	
3.6.8	200 digits	
3.6.9	500 digits	
3. 6.10	1000 digits	
3.9.	Reference value calculation resolution	
3.9.1*	Display accuracy	
3.9.2	Display accuracy +1 decimal place	
3.9.3	Display accuracy +2 decimal places	
3.9.4	Internal resolution	
3.10.	Decimal places in displayed result	
3.10.1*	none	
3.10.2	1 decimal place	
3.10.3	2 decimal places	
3.10.4	3 decimal places	
3.11.	Parameter for saving weight values	
3.11.1*	With stability	
3.11.2	With increased stability	
3.13.	Reference weighing instrument	
3.13.1*	Off	
3.13.2	Weighing platform WP 1	
3.13.3	Weighing platform WP 2	

\* = Factory setting

- Save the settings with the  key and exit Setup: Press the  key several times.

**Parameter for saving weight values**

The reference weight is saved when the scale has stabilized.

“Stability” is defined as the point at which the fluctuation of a measured value lies within a defined tolerance range. The narrower the tolerance range, the more stable the platform is at “stability”.

In Setup, under:

APPL:  NM: 3.11.

Signum® 3:

APPL 1:

NEUTR.M:3.11.

You can define whether the value is saved when “standard stability” is reached, or only at “increased stability” (narrower tolerance range). If you select “increased stability” the reference weight saved will be more accurate and the results more reproducible, but the response time of the weighing platform might be longer.

**Accuracy Level for Calculation of Reference Value**

The resolution applied for calculating the reference weight is defined in Setup under:

APPL:  NM: 3.9.

Signum® 3:

APPL 1:

NEUTR.M: 3.9.

The resolution for calculating the reference weight is increased if “+1 decimal place,” “+2 decimal places” or “Internal resolution” is selected. With the “+1 decimal place” setting, the net value is determined to one additional decimal place (i.e., display accuracy x 10); “+2 decimal places” increases display accuracy x 100, and “Internal resolution” uses the maximum resolution available.

**Decimal Places in Displayed Result**

In neutral measurement, not only whole numbers but also decimal numbers (for example, 1.25 □ electrical cabling) can be displayed. The number of decimal places displayed in neutral measurement is configured in Setup under:

APPL:  NM: 3.10.

Signum® 3:

APPL 1:

NEUTR.M: 3.10.

**Minimum load**

The minimum load required for initialization of the weighing platform is configured in Setup under:

APPL:  NM: 3.6.

Signum® 3:

APPL 1:

NEUTR.M: 3.6.

Once the limit is exceeded by the load, initialization can begin.

If the load on platform is too light, the following will occur when you try to save a value:

- The error code *INF 29* is displayed
- A warning signal is emitted (double-beep)
- The weighing platform is not initialized
- The preset calculation factor is saved

The minimum load required for automatic taring of the container weight on the platform (first weight) is configured in Setup under:

APPL:  NM: 3.5.

Signum® 3:

APPL: M.WEIGH: 3.5.

You can choose from the following 10 levels for this setting:

- 1 digit
- 2 digits
- 5 digits
- 10 digits
- 20 digits
- 50 digits
- 100 digits
- 200 digits
- 500 digits
- 1000 digits

The “digits” here refer to the scale intervals in the connected weighing platform. If the interval of the connected platform is 1 g, for example, and 1000 digits are required, you must place at least 1000 g (= 1000 intervals = 1000 digits) on the weighing platform for initialization.

**Neutral Measurement with Two Weighing Platforms**

You can use two weighing platforms simultaneously with the Neutral Measurement application. When using two platforms, you can choose from the following operating modes:

- Neutral measurement with two weighing platforms
- Neutral measurement with one reference platform and one weighing platform

Neutral measurement with two platforms of the same type:

Use this operating mode to measure different types of sample material with different weights. For example, measure the lighter-weight samples on one platform and the heavier samples on another.

You can define one of the two platforms as the default scale.

This is configured in Setup, under:

SETUP:

UTILIT:

B.11: (main scale)

This is the first platform active when you switch on the Signum, regardless of the setting for automatic initialization of the Neutral Measurement application.

Neutral Measurement with One Reference Platform and One Weighing Platform:

In this operating mode, the reference platform is a high-resolution weighing platform with a relatively low maximum capacity. The other platform is used for weighing heavier samples, and has a high capacity with a relatively low resolution.

This allows you to both determine the reference weight with high resolution; i.e., very precisely, and to measure large samples, without requiring an expensive high-resolution, high-capacity weighing platform.

The system can be configured to switch automatically to the reference platform for initialization. Following initialization, the platform for larger amounts is automatically activated.

The definition of one weighing platform as a reference platform is configured in Setup, under:

APPL:  NM: 3.13.

Signum® 3:

APPL 1:

NEUTR.M: 3.13.

**Example:**

Measuring 25 m of electrical cable.

Settings (different from the factory settings):

Setup: Application 1: Neutral measurement

Setup: Printout; PRTPROT 7.6.

then select the menu line items of your choice

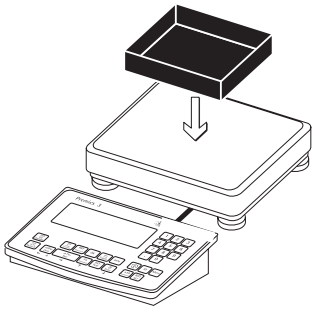

1.) Place empty container on the platform

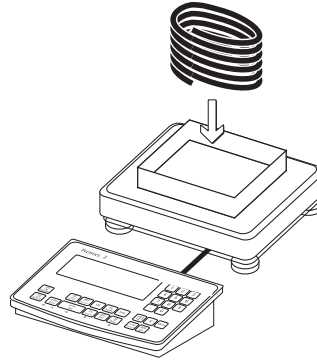

5.) Place the desired amount of cable in the container



2.) Tare the scale

Note: If the automatic tare function is enabled, you do not need to press the  key to tare the platform; the tare weight is saved automatically when you place the container on the platform

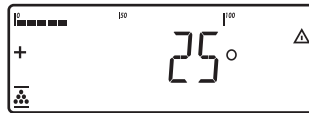
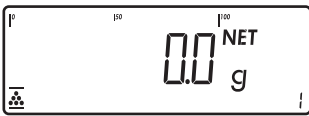

Read the result

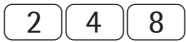

3.) Signum® 3 only:

Enter the weight of 1 meter of cable using the keypad (in this example, 248 g)

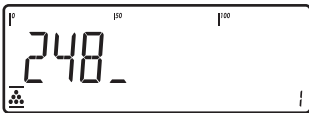

6.) Print the results



4.) Save the value entered as the reference weight

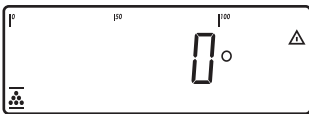

nRef	+	1	o
wRef	+	0.248	kg
G#	+	6.794	kg
T	+	0.541	kg
N	+	6.253	kg

Configured printout:  
see page 81



Qnt	25	o
-----		

## Averaging (Animal Weighing) Application

With the Averaging application, you can use your weighing platform for calculating weights as the average of a number of individual weighing operations. These individual operations are also known as “subweighing operations.”

This function is used to determine weights under unstable ambient conditions or for weighing unstable samples (such as live animals).



### Characteristics

- Averaging started manually or automatically. Configured in Setup under:  
*APPL 1: ANIM.WG: 3.1B.*  
With manual start selected, the averaging routine begins when you press a key (provided the start conditions are met). With automatic start selected, averaging begins when you place the first load on the platform (provided the start conditions are met).  
  
Signum® 3 only:  
- Enter the number of subweighing operations using the keypad  
  
Signum® 2 only:  
- Use the **[REF]** key to select the number of measurements for averaging
- Info mode
- Toggle the display from “result of last measurement” to “current weight” by pressing the **[S]** key
- Automatic printout configured in Setup under:  
*APPL: : 3.2D.*  
Signum® 3:  
*APPL 1:  
ANIM.WG: 3.2D.*
- Automatic taring of container weight. Configured in Setup under:  
*APPL: : 3.7.*  
Signum® 3:  
*APPL 1:  
ANIM.WG: 3.7.*
- Automatic start of averaging when the scale is turned on and a sample placed on the platform (provided start conditions are met). Configured in Setup under:  
*APPL: : 3.8.*  
Signum® 3:  
*APPL: A.START: 3.8.*

- Exit application, delete parameters: The number of measurements remain in memory until the application is changed or the value is overwritten or deleted via the **[CF]** key. The number of measurements also remains saved after the scale is turned off.

Signum® 3 only:

You can assign different functions to the **[CF]** key for deleting applications. When you clear applications, you can delete either the data stored for all applications or just the data stored for the active application. Configured in Setup under:  
*APPL: SEL.CF: 3.24.*  
(Sel. CF function key **[CF]** in applications)

- Tare function:  
If you store a tare (weight value) by pressing the **[T+]** key, you can later enter a value manually. The value you enter is added to the stored tare value. Setting: menu code 3.25.1 (factory setting)  
A value entered manually overwrites a stored tare value (weight value). If you enter a value manually, a tare value (weight value) stored later overwrites the manually entered value. Setting: menu code 3.25.2  
Configured in Setup under: Signum® 2  
*APPL: : 3.25.*  
Signum® 3:  
*APPL: TARE.F: 3.25.*
- Restore factory default settings. Configured in Setup under:  
*APPL: : 9.9. 1.*

Signum® 3:  
*APPL: DEF.APP: 9. 1.*

A number of subweighing operations are required to form the basis for calculation of an average weight. You can enter the desired number of subweighing operations using the keypad.







The number you enter is active until it is overwritten by another number. It also remains in memory when you switch to a different application program, or turn off the scale.

There are three ways to start the averaging routine:

- Manual start with preset number of subweighing operations: Place the sample on the platform and press the **[OK]** key
- Manual start with user-defined number of subweighing operations: Place the sample on the platform and enter the number of weighing operations using the keypad. Press the **[REF]** key to save the number entered and begin weighing.
- Automatic start with preset number of subweighing operations: Measurement begins when you place the first sample on the platform, provided the start conditions are met.



**Preparation**

- Switch on the scale: Press the  key
- While all segments are lit, press the  key
- Select the Setup menu: Press the  key repeatedly until *APPL* is displayed
- Confirm *APPL*: Press the  key
- Select the Animal Weighing application: Press the  key repeatedly and confirm with the  key

Application Parameters: Animal Weighing

—	3. 6.	Minimum load for start	
—	—	3.6.1*	1 digit
—	—	3.6.2	2 digits
—	—	3.6.3	5 digits
—	—	3.6.4	10 digits
—	—	3.6.5	20 digits
—	—	3.6.6	50 digits
—	—	3.6.7	100 digits
—	—	3.6.8	200 digits
—	—	3.6.9	500 digits
—	—	3.6.10	1000 digits
—	3.18.	Start of averaging	
—	—	3.18.1*	Manual
—	—	3.18.2	Automatic
—	3.19.	Animal activity	
—	—	3.19.1	0.1% of the animal/ object
—	—	3.19.2*	0.2% of the animal/ object
—	—	3.19.3	0.5% of the animal/ object
—	—	3.19.4	1% of the animal/object
—	—	3.19.5	2% of the animal/object
—	—	3.19.6	5% of the animal/object
—	—	3.19.7	10% of the animal/ object
—	—	3.19.8	20% of the animal/ object
—	—	3.19.9	50% of the animal/ object
—	—	3.19.10	100% of the animal/ object
—	3.20.	Auto Results printout	
—	—	3.20.1*	Off
—	—	3.20.2	On
—	3.21.	Static display of result after load removed	
—	—	3.21.1*	Display is fixed until unload threshold reached
—	—	3.21.2	Fixed display until  is pressed

\* = Factory setting

**Minimum load**

The minimum load required for initialization of the averaging routine is configured in Setup under:

*APPL* :  : 3.6.

Signum® 3:

*APPL* 1:

*ANIM.WG*: 3.6.

Setting a minimum load for averaging can be especially useful if you configure automatic start of measurement.

The minimum load required for automatic taring of the container weight on the platform (first weight), or for automatic printout of results, is configured in Setup under:

*APPL* :  : 3.5.

Signum® 3:

*APPL* : *A.TARE* : 3.5.

You can choose from the following 10 levels for this setting:

- 1 digit
- 2 digits
- 5 digits
- 10 digits
- 20 digits
- 50 digits
- 100 digits
- 200 digits
- 500 digits
- 1000 digits

The “digits” here refer to the scale intervals in the connected weighing platform. If the interval of the connected platform is 1 g, for example, and 1000 digits are required, you must place at least 1000 g (= 1000 intervals = 1000 digits) on the weighing platform to start the averaging routine.

**Starting the Measurements**

The averaging routine does not begin until the fluctuation in weight value remains below a defined threshold over three consecutive measurements. The tolerance limit is defined as a percentage of the animal or object weight (for example, 0.1%, 0.2%, ..., 50%, 100%), configured in Setup under:

*APPL* :  : 3.19.

Signum® 3:

*APPL* 1:

*ANIM.WG*: 3.19.

If the “Averaging” parameter is set to 2%, for example, and the animal or object weighs 10 kg, measurement does not begin until the fluctuation in weight value remains below 200 g during three consecutive measurements.

**Display**

A calculated average value is shown continuously on the main display. The  symbol (indicating a calculated value) is also displayed.

You can toggle between this display to a readout of the current weight on the platform by pressing the  key.

In the Setup menu, under:



*APPL* :  : 3.21.



Signum® 3:

*APPL* 1:

*ANIM.WG*: 3.21.

You can select “Display is static until unload threshold reached” to have the display switch automatically to the weight readout when you unload the weighing platform (i.e., when the load is less than half the minimum load). The result of the most recent averaging operation is not saved.

If you select “Display is static until the  key is pressed,” the calculated average remains displayed even after the weighing platform is unloaded, until you press the  key to begin a new measurement.

- Save the settings with the  key and exit Setup: Press the  key several times.

**Example:**

Measuring the weight of one mouse.

Settings (different from the factory settings):

Setup: Application 1: Animal weighing

Setup: Printout; PRTPROT 7.6 then select the menu line items of your choice

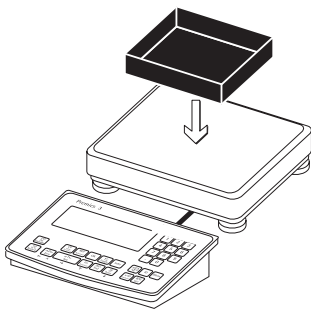

Place empty container on the platform.

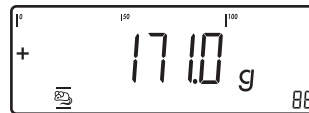

The averaging routine does not begin until the fluctuation in weight value remains below a defined threshold over three consecutive measurements. The number of subweighing operations remaining is shown in the numeric display.



Read off the result of averaging



1.) Tare the scale.

Note: If the automatic tare function is enabled, you do not need to press the  key to tare the platform; the tare weight is saved automatically when you place the container on the platform.



5.) Print the results.

Note: If automatic printout of results is enabled, you do not need to press the  key. The results are printed automatically.

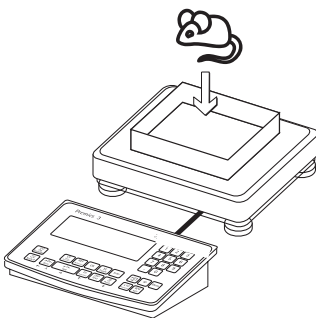

2.) Place 1st animal in container.

mDef + 20  
T + 0.292 kg  
x-Net + 0.183 kg  
-----

Configured printout:  
see page 81



3.) Signum® 3 only:

Enter the number of subweighing operations using the keypad (in this example, 20 measurements).

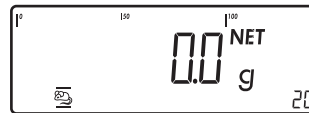
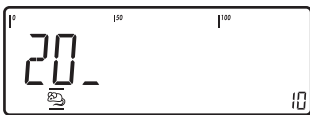

When you unload the weighing platform, the display switches to the weight readout automatically, unless configured otherwise in Setup. The weighing instrument is ready for the next measurement.







4.) Save the value entered and begin averaging.



## Weighing in Percent Application %

With the Weighing in Percent application, you can use your weighing platform to obtain weight readouts in percent which are in proportion to a reference weight.  
 %  displayed as the weight unit.



### Characteristics

- Save the current weight value as reference weight “pRef”  
 Signum® 3 only:
- Enter the reference weight “Wxx%” for 100% using the keypad  
 Signum® 3 only:
- Enter the reference percentage “pRef” using the keypad
- Enter reference sample weight using a barcode scanner
- Display result as loss (difference) or residue
- Display up to 3 decimal places.  
 Configured in Setup under:  
 APPL 1:  
 PERC.WG: 3.10.
- Weighing in percent with two weighing platforms
- Activate Info mode via the  key
- Toggle the display between percent and weight via the  key.
- Automatic taring of container weight.  
 Configured in Setup under:  
 APPL %: 3.7.  
 Signum® 3:  
 A.TARE: 3.7.
- Automatic initialization when the scale is switched on. The application is initialized with the most recently saved data. Configured in Setup under:  
 APPL %: 3.8.  
 Signum® 3:  
 A.START: 3.8.
- Exit application, delete parameters:  
 The value of the reference weight in the memory remains active until the application is changed or the value is overwritten or deleted via the  key. The value also remains saved after the scale is turned off.  
 Signum® 3 only:  
 You can assign different functions to the  key for deleting applications. When you clear applications, you can delete either the data stored for all applications or just the data stored for the active application. Configured in Setup under:  
 APPL: SEL.CF: 3.24.  
 (Sel. CF function key  in applications)

- Tare function:  
 1) If you store a tare (weight value) by pressing the  key, you can later enter a value manually. The value you enter is added to the stored tare value. Setting: menu code 3.25.1 (factory setting)  
 2) A value entered manually overwrites a stored tare value (weight value). If you enter a value manually, a tare value (weight value) stored later overwrites the manually entered value. Setting: menu code 3.25.2  
 Configured in Setup under:  
 APPL: %: 3.25.  
 Signum® 3:  
 APPL: TARE.F: 3.25.







- Restore factory default settings.  
 Configured in Setup under:  
 APPL: %: 9.9.1.  
 Signum® 3:  
 APPL: DEF.APP: 9.1.

To determine the weight of a sample relative to a reference weight, you need to define the reference percentage value. There are three ways to enter this value in the application program:

- Calculation:  
  - Place the reference quantity (defined by the reference percentage) on the connected weighing platform and press the  key to initialize the application.
  - Place any amount of the sample material on the connected weighing platform, enter the reference percentage through the keypad, and press the  key to initialize the application.
 How the reference weight is calculated depends on the application setting that defines “Accuracy for saving weights”. The value is either rounded off in accordance with the display resolution, or saved with 10-fold or 100-fold resolution, or with the maximum internal resolution of the weighing platform.
- Enter the reference weight for 100% using the keypad and press the  key to initialize the application.
- Use a barcode scanner.

The initialization data remains valid until deleted by pressing the  key or until overwritten by a new value. They remain saved after the Signum® is switched off.



### Preparation

- Switch on the scale: Press the  key
- While all segments are lit, press the  key
- Select the Setup menu: Press the  key repeatedly until *APPL* is displayed
- Confirm *APPL*: Press the  key
- Select the Weighing in Percent application:  
 Press the  key repeatedly and confirm with the  key

### Weighing in Percent Application Parameters

3. 6.	Minimum load for initialization	
3.6.1*	1 digit	
3.6.2	2 digits	
3.6.3	5 digits	
3.6.4	10 digits	
3.6.5	20 digits	
3.6.6	50 digits	
3.6.7	100 digits	
3.6.8	200 digits	
3.6.9	500 digits	
3.6.10	1000 digits	
3. 9.	Reference value calculation resolution	
3.9.1*	Display accuracy	
3.9.2	Display accuracy +1 decimal place	
3.9.3	Display accuracy +2 decimal places	
3.9.4	Internal resolution	
3.10.	Decimal places in displayed result	
3.10.1*	none	
3.10.2	1 decimal place	
3.10.3	2 decimal places	
3.10.4	3 decimal places	
3.11	Parameter for saving weight values	
3.11.1*	With stability	
3.11.2	With increased stability	
3.13.	Reference weighing instrument	
3.13.1*	No weighing platform selected	
3.13.2	Weighing platform WP 1	
3.13.3	Weighing platform WP 2	
3.15.	Display of calculated values	
3.15.1*	Residual qty.	
3.15.2	Loss	

\* = Factory setting

- Save the settings with the  key and exit Setup: Press the  key several times.

**Parameter for saving weight values**

The reference weight is saved when the scale has stabilized.

“Stability” is defined as the point at which the fluctuation of a measured value lies within a defined tolerance range. The narrower the tolerance range, the more stable the platform is at “stability”.

In Setup, under:

*APPL : %: 3. 11.*

Signum® 3:

*APPL 1:*

*PERC.WG: 3. 11.*

You can define whether the value is saved when “standard stability” is reached, or only at “increased stability” (narrower tolerance range). If you select “increased stability” the reference weight saved will be more accurate and the results more reproducible, but the response time of the weighing platform might be longer.

**Accuracy of Average Piece Weight Calculation**

The resolution applied for calculating the reference weight is defined in Setup under:

*APPL : %: 3.9.*

Signum® 3:

*APPL 1:*

*PERC.WG: 3.9.*

The resolution for calculating the reference weight is increased if “+1 decimal place,” “+2 decimal places” or “Internal resolution” is selected. With the “+1 decimal place” setting, the net value is determined to one additional decimal place (i.e., display accuracy x 10); “+2 decimal places” increases display accuracy x 100, and “Internal resolution” uses the maximum resolution available.

**Result display**

With the Weighing in Percent application, the result can be displayed as a remainder or loss.

Configured in Setup under:

*APPL : %: 3. 15.*

Signum® 3:

*APPL 1:*

*PERC.WG: 3. 15.*

Equations:

Residual qty. = (current weight – 100% weight) / \* 100

Loss = (current weight – 100% weight) / 100% weight \* 100

**Minimum load**

The minimum load required for initialization of the weighing platform is configured in Setup under:

*APPL : %: 3.6.*

Signum® 3:

*APPL 1:*

*PERC.WG: 3.6.*

Once the limit is exceeded by the load, initialization can begin. If the load on platform is too light, the following will occur when you try to save a value:

- The error code *INF 29* is displayed
- The weighing platform is not initialized
- The preset reference percentage is saved

The minimum load required for automatic taring of the container weight on the platform (first weight) is configured in Setup under:

*APPL : %: 3.5.*

Signum® 3:

*APPL:M.WEIGH: 3.5.*

You can choose from the following 10 levels for this setting:

1 digit  
2 digits  
5 digits  
10 digits  
20 digits  
50 digits  
100 digits  
200 digits  
500 digits  
1000 digits

The “digits” here refer to the scale intervals in the connected weighing platform. If the interval of the connected platform is 1 g, for example, and 1000 digits are required, you must place at least 1000 g (= 1000 intervals = 1000 digits) on the weighing platform for initialization.

**Weighing in percent with two weighing platforms**

You can use two weighing platforms simultaneously with the Weighing in Percent application. When using two platforms, you can choose from the following operating modes:

- Weighing in percent with two platforms of the same type
- Weighing in percent with one reference platform and one weighing platform

Weighing in percent with two platforms of the same type:

Use this operating mode to measure different types of sample material with different weights. For example, measure the lighter-weight samples on one platform and the heavier samples on another.

You can define one of the two platforms as the default scale.

This is configured in Setup, under:

*SETUP: UTILIT: 8. 11.*

(main scale)

This is the first platform active when you switch on the Signum® 2 or Signum® 3, regardless of the setting for automatic initialization of the Weighing in Percent application.

Weighing in percent with one reference platform and one weighing platform  
In this operating mode, the reference platform is a high-resolution weighing platform with a relatively low maximum capacity. The other platform is used for weighing heavier samples, and has a high capacity with a relatively low resolution.

This allows you to both determine the reference weight with high resolution; i.e., very precisely, and to measure large samples, without requiring an expensive high-resolution, high-capacity weighing platform.

The system can be configured to switch automatically to the reference platform for initialization (the measured value line shows *REF*). Following initialization, the platform for larger amounts is automatically activated.

The definition of one weighing platform as a reference platform is configured in Setup, under:

*APPL : %: 3. 13.*

Signum® 3:

*APPL 1:*

*PERC.WG: 3. 13.*

**Example:**  
 Weighing in 100% of a sample material.  
 Settings (different from the factory settings):  
 Setup: Application 1: Weighing in Percent  
 Setup: Printout, PRTPROT 7.6, then select the menu line items of your choice

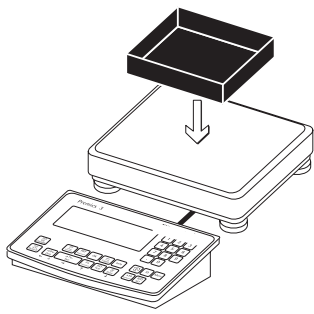

1.) Place empty container on the platform

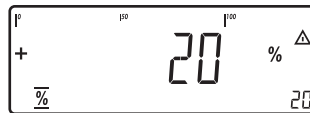

If the weight is too light, an error code is shown in the main display: *INF 29*

Reduce the minimum load setting

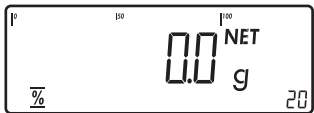

2.) Tare the scale  
 Note: If the automatic tare function is enabled, you do not need to press the  $\rightarrow T \leftarrow$  key to tare the platform; the tare weight is saved automatically when you place the container on the platform.

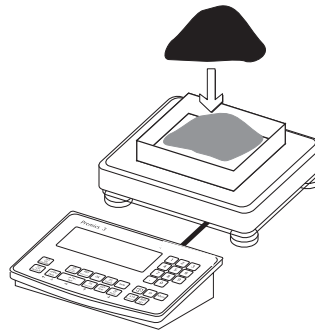

5.) Continue filling the container until the target amount is reached (in this example, 100%)

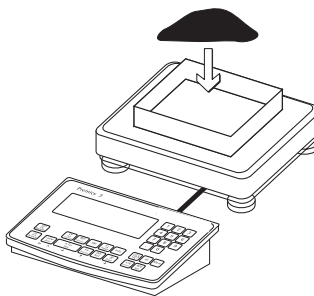

3.) Add reference material in accordance with reference percentage (in this example, 85 g)

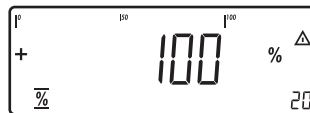

6.) Print the results

pRef + 20 %  
 wRef + 0.085 kg

Configured printout:  
 see page 81



4.) Begin calculation of reference weight. The calculation is based on the active net weight value and the reference percentage entered.

G# + 1.080 kg  
 T + 0.675 kg  
 N + 0.423 kg  
 Prc + 100 %  
 -----

## Checkweighing Application

With the Checkweighing application, you can check whether the sample on the weighing platform matches a target value or lies within a given tolerance range.

Checkweighing also makes it easy to fill sample materials to a specified target weight.

### Characteristics

Signum® 3 only:

- Enter the nominal or target weight (set point) and the tolerance range delimiters either using the keypad or by saving the weight value of a load on the platform.

- Enter the tolerance limits as absolute values (Min and Max) or as percentages of the target. For Signum 3, additional user-defined percent limits (4.5.3) or relative limits (4.5.4) can be entered. Configured in the menu under:

APPL: : 4.5.

Signum® 3:

APPL 2:

CHECK.WG: 4.5.

- The target value can be taken over as a weighed value from a weighing platform, and the upper and lower tolerance limits are defined as a percentage deviation from the target value (setting code 4.5.2). The deviation percentage can be changed using the key: 0.1%, 0.2%, 0.5%, 1%, 1.5%, 2%, 3%, 5% or 10%.

- The target value, lower tolerance limit (minimum) and upper tolerance limit (maximum) can be applied as weighed values from the weighing platform.

- Target and tolerance limits checked during input; values must conform to: upper limit  $\geq$  target  $\geq$  lower limit  $\geq$  1 digit.

- Checkweighing range: either 30% to 170% of the target, or from 10% to infinity.

- Results are shown on the main display as a colored bar graph (yellow, green, red) as well as sent to control output ports for further processing.

- Toggle the main display between weight and tolerances limits by pressing the key. If the weight in the readout is outside the tolerance range, “LL” (too low) or “HH” (too high) is displayed.

- Activate Info mode via the key

- Automatic printout configured in Setup under:

APPL: : 4.6.

Signum® 3:

APPL 2:

CHECK.WG: 4.6.

- Automatic taring of container weight Configured in Setup under:

APPL: : 3.7.

Signum® 3:

APPL: A.TARE: 3.7.

- Automatic initialization when you switch on the scale with most recently saved application data. Configured in Setup under:

APPL: : 3.8.

Signum® 3:

APPL: A.START: 3.8.

Signum® 3 only:

- You can assign different functions to the key for deleting applications. When you clear applications, you can delete either the data stored for all applications or just the data stored for the active application. Configured in Setup under:

APPL: SEL.CF: 3.24.

(Sel. CF function key in applications)

- Tare function:
  - 1) If you store a tare (weight value) by pressing the , you can later enter a value manually. The value you enter is added to the stored tare value. Setting: menu code 3.25.1 (factory setting)

2) A value entered manually overwrites a stored tare value (weight value).

If you enter a value manually, a tare value (weight value) stored later overwrites the manually entered value.

Setting: menu code 3.25.2

Configured in Setup under:

Signum® 2:

APPL: : 3.25.;

Signum® 3:

APPL: TARE.F: 3.25.

- Restore factory default settings. Configured in Setup under:

Signum® 2:

APPL: : 9. 1.

Signum® 3:

APPL: DEF.APP: 9. 1.

Checkweighing entails comparing the current weight value to a defined target. You can enter the value for this target using the keypad, or by saving the weight value indicated. You can also define upper and lower tolerance limits based on this target. You can do this by:

- Entering absolute values using the keypad or placing the desired amount of weight on the platform and saving the value, or
- entering each value as a percentage of the target weight

The initialization data remains valid until deleted by pressing the key or until overwritten by a new value. They remain saved after the scale is switched off.

### Preparation

- Switch on the scale: Press the key
- While all segments are lit, press the key
- Select the Setup menu: Press the key repeatedly until SETUP is displayed
- Open the Setup menu: Press the key
- Select the Checkweighing application: Press the key repeatedly and confirm with the key

Application parameters: Checkweighing

4.2.	Checkweighing range
4.2.1*	30 to 170%
4.2.2	10% to infinity
4.3.	Control output for SET as:
4.3.1*	SET output
4.3.2	Ready to operate
4.4.	Activation of outputs
4.4.1	Off
4.4.2	Always on
4.4.3	At stability
4.4.4*	Within checkweighing range
4.4.5	On at stability within checkweighing range
4.5.	Parameter input
4.5.1*	Min, Max, target, Absolute value
4.5.2	Only target value with percent limits
4.5.3	Target value with user-defined percent limits.
4.5.4	Target value; min/max value as relative weight to target value.
4.6.	Automatic printing
4.6.1*	Off
4.6.2	On
4.6.3	Only values within tolerance
4.6.4	Only values outside tolerance
4.7.	Checkweighing toward zero
4.7.1*	Off
4.7.2	On

\* = Factory setting

- Save the settings with the key and exit Setup: Press the key several times.

**Minimum Load**

The minimum load required for automatic taring of the container weight on the platform (first weight), or for automatic printout of results, is configured in Setup under:

*APPL*: : 3.5.

Signum® 3:

*APPL*: *M.WEIGH*: 3.5.

You can choose from the following 10 levels for this setting:

- 1 digit (no minimum load)
- 2 digits
- 5 digits
- 10 digits
- 20 digits
- 50 digits
- 100 digits
- 200 digits
- 500 digits
- 1000 digits

The “digits” here refer to the scale intervals in the connected weighing platform. If the interval of the connected platform is 1 g, for example, and 1000 digits are required, you must place at least 1000 g (= 1000 intervals = 1000 digits) on the weighing platform to activate autotaring or autoprint.

**Display**

The result of a measurement is shown either as a weight value or in relation to the target.

- Weight display  
The measured value line always shows the weight value, even if it lies outside the tolerance range.

The bar graph is displayed with symbols indicating lower limit, target and upper limit. Weights are shown logarithmically up to the lower tolerance limit, and linearly beyond that point.

- Relation to target value

As “Weight display” above, with the exception that:

- *LL* appears in the main display if the weight value is less than the target
- *HH* is shown on the main display if the weight value is higher than the target

**Digital I/O Interface**

The Checkweighing application supports the digital input/output-interface.

There are 4 control lines, or outputs, which are activated as follows (see also the diagram below):

- Lighter
- Equal
- Heavier
- Set

In Setup, under:

*APPL*: : 4.4.

Signum® 3:

*APPL* 2:

*CHECK.WG*: 4.4.

you can define whether these control ports are

- switched off
- always on
- on at stability
- on within checkweighing range
- on at stability within checkweighing range

The “SET” output normally changes its voltage level when the load is near the target weight. Alternatively, you can assign the “Ready for use” function to this port. Configured in Setup under:

*APPL*: : 4.3.

Signum® 3:

*APPL* 2:

*CHECK.WG*: 4.3.

This makes it possible, for example, to connect a simple indicator for weighing or calculation results.

All data output ports have a high voltage level when:

- The application has not been initialized
- The weighing instrument is not at stability and the “at stability ...” parameter is selected
- The weight is not within checkweighing range

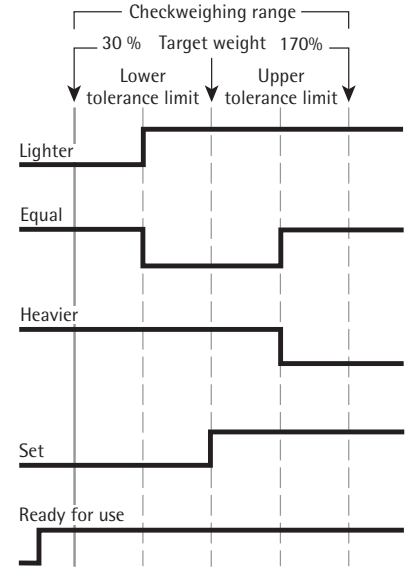

Digital I/O Interface

- “Set” control output: set
- Activation of ports: always on

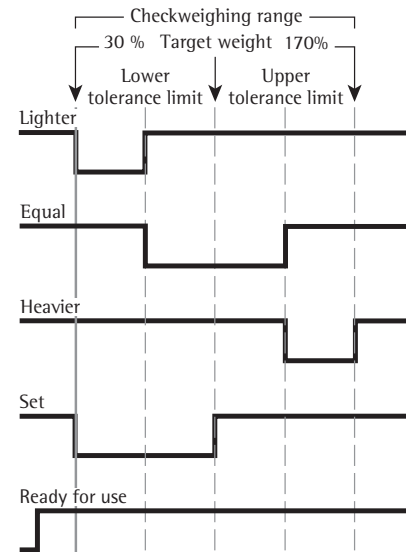

Digital I/O Interface

- <SET> control output set
- Port lines: within checkweighing range

Output port specifications:

- When not in use, the voltage level is high: >3.7 V/+4 mA
- When activated, the voltage level is low: <0.4 V/-4 mA

⚠ The data outputs are not protected from short circuits.

**Example: 1**

Checkweighing samples with a target weight of 1250 g and a tolerance range from -10 g to +30 g (using the factory-set application parameters)

Settings (different from the factory settings):

Setup: Application 2: Checkweighing

Setup: Printout, PRTPROT: 7.6, then select the menu line items of your choice



OK



1.) Begin input of target and tolerance values

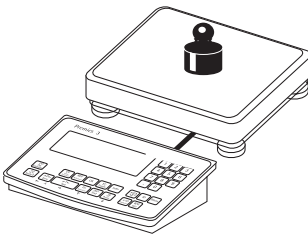

2.) Place a sample with the target weight (in this example, 1250 g) on the platform

OK



3.) Save target value

1 2 4 0

4.) Signum® 3 only:  
Enter value for lower limit (in this example, 1240 kg)



OK

5.) Save value for the lower limit



1 2 8 0

6.) Signum® 3 only:  
Enter value for the upper limit (in this example, 1280 kg)

OK

Save value for upper limit



7.) Weigh samples



8.) Print the results  
Note: If automatic printout of results is enabled, you do not need to press the key. The results are printed automatically.

Setp	+	1.250 kg
Min	+	1.240 kg
Max	+	1.280 kg
G#	+	1.256 kg
T	+	0.000 kg
N	+	1.256 kg
Lim	+	0.48 %
W.Diff+		0.006 kg

Target  
Minimum  
Maximum

Gross weight  
Tare weight  
Net weight

Percentage of deviation from target\*  
Absolute deviation from target

\* When displayed in relation to target value:  
If the weight is lighter than the lower limit, the display shows: LL

If the weight is heavier than the target, the display shows: HH

## Checkweighing Toward Zero Application

### Example: 2

Checkweighing samples with a target weight of 1250 g and a tolerance range from -10 g to +30 g (using the factory-set application parameters)

Settings (different from the factory settings):

Setup: Application 2: Checkweighing toward zero (parameter 4. 7. 2)

Setup: Printout, PRTPROT 7.6, then select the menu line items of your choice

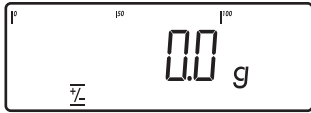

OK

1.) Begin input of target and tolerance values

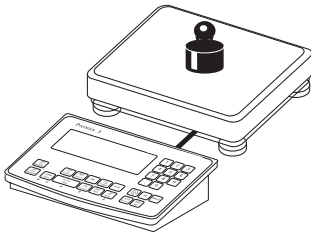

2.) Place a sample with the target weight (in this example, 1250 g) on the platform

OK

3.) Save target value



1 2 4 0

4.) For Signum® 3 only:  
Enter value for lower limit  
(in this example, 1240 kg)



OK

5.) Save value for the lower limit



1 2 8 0

6.) For Signum® 3 only:  
Enter value for the upper limit  
(in this example, 1280 kg)

OK

Save value for upper limit



7.) Weigh samples



8.) Print the results  
Note: If automatic printout of results is enabled, you do not need to press the  key. The results are printed automatically.

Setp	+	1.250	kg
Min	+	1.240	kg
Max	+	1.280	kg
G#	+	1.256	kg
T	+	0.000	kg
N	+	1.256	kg
Lim	+	0.48	%
W.Diff+		0.006	kg
-----			

Target  
Minimum  
Maximum

Gross Weight  
Tare weight  
Net Weight

Percentage of deviation from target\*  
Absolute deviation from target

\* When displayed in relation to target value:  
If the weight is lighter than the target, the display shows:  
LL

If the weight is heavier than the target, the display shows:  
HH



## Classification Application

With the Classification application, you can determine whether the weight of a given sample lies within the limits of a defined weight class.

### Characteristics

- Classification with 3 or 5 weight classes. Configured in Setup under:

*APPL*: : 4.8.

Signum® 3:

*APPL* 2:

*CLASS*: 4.8.

- Enter the upper class limits using the keypad or by saving weight values from a load on the platform

- Enter the upper limits of weight classes as absolute values or as a percentage of deviation from the upper limit of Class 1 Configured in the menu under:

*APPL*: : 4.9.

Signum® 3:

*APPL* 2:

*CLASS*: 4.9.

- Activate Info mode via the  key

- Toggle the main display between classification display and tolerances limits by pressing the  key

- Automatic printout configured in Setup under:

*APPL*: : 4. 10.

Signum® 3:

*APPL* 2:

*CLASS*: 4. 10.

- Automatic taring of container weight. Configured in Setup under:

*APPL*: : 3.7.

Signum® 3:

*APPL*: *A.TARE*: 3.7.

- Automatic initialization when you switch on the scale with most recently saved application data. Configured in Setup under:

*APPL*: : 3.8.

Signum® 3:

*APPL*: *A.START*: 3.8.

Signum® 3 only:

You can assign different functions to the  key for deleting applications. When you clear applications, you can delete either the data stored for all applications or just the data stored for the active application. Configured in Setup under:

*APPL*: *SEL.CF*: 3.24.

(Sel. CF function key  in applications)

- Tare function:
  - 1) If you store a tare (weight value) by pressing the  key, you can later enter a value manually. The value you enter is added to the stored tare value. Setting: menu code 3.25.1 (factory setting)
  - 2) A value entered manually overwrites a stored tare value (weight value). If you enter a value manually, a tare value (weight value) stored later overwrites the manually entered value. Setting: menu code 3.25.2
 Configured in Setup under:
 

Signum® 2:  
*APPL*: *TARE.F*: 3.25.  
Signum® 3:  
*APPL*: : 3.25.
- Restore factory default settings. Configured in Setup under:
 

*APPL*: : 9. 1.  
Signum® 3:  
*APPL*: *DEF.APP*: 9. 1.







To use the Classification application, you need to enter the delimiters that separate one class from another.

Limits between the individual weight classes are required for the classification. The lower limit of Class 1 is defined by the preset minimum load. The other classes are configured by defining their upper limits. There are two ways to enter the delimiters for classes 1 through 3 (or 5):

- By saving the weight value indicated: Each upper limit value, with the exception of the highest class, is entered using the keypad or by saving the weight value of a load on the weighing platform.
- By entering a percentage: The upper value of Class 1 is entered using the keypad or by saving the value indicated. Upper limits for the other classes are defined by entering a percentage of deviation from the upper limit of Class 1, using the keypad. Example: Enter 100 g as the upper limit of Class 1. Then enter 15%. When working with 3 classes, this yields the following weight classes:  
Class 0: up to the minimum load  
Class 1: >minimum load - 100 g  
Class 2: >100 g - 115 g  
Class 3: >115 g - maximum load  
When working with 5 classes, this yields the following weight classes:  
Class 0: up to the minimum load  
Class 1: >minimum load - 100 g  
Class 2: >100 g - 115 g  
Class 3: >115 g - 130 g  
Class 4: >130 g - 145 g  
Class 5: >145 g - maximum load

The initialization data remains valid until deleted by pressing the  key or until overwritten by a new value. They remain saved after the scale is switched off.



### Preparation

- Switch on the scale: Press the  key
- While all segments are lit, press the  key
- Select the Setup menu: Press the  key repeatedly until *APPL* is displayed
- Confirm *APPL*: Press the  key
- Select the Classification application: Press the  key repeatedly and confirm with the  key

w Classification Application Parameters

3.6.	Minimum Load for Initialization and Defining the Class 1 Lower Limit	
3.6.1*	1 digit	
3.6.2	2 digits	
3.6.3	5 digits	
3.6.4	10 digits	
3.6.5	20 digits	
3.6.6	50 digits	
3.6.7	100 digits	
3.6.8	200 digits	
3.6.9	500 digits	
3.6.10	1000 digits	
4.3.	Control output for SET as:	
4.3.1*	SET output	
4.3.2	Ready to operate for process control systems	
4.7.	Activation of outputs	
4.7.1	Off	
4.7.2	Always on	
4.7.3*	On at stability	
4.8.	Number of classes	
4.8.1*	3 classes	
4.8.2	5 classes	
4.9.	Parameter input	
4.9.1*	Weight values	
4.9.2	Percentage	
4.10.	Automatic printing	
4.10.1*	Off	
4.10.2	On	

\* = Factory setting

- Save the settings with the  key and exit Setup: Press the  key several times.



**Minimum load**

The minimum load for the first class is configured in Setup under:

APPL:  3.6.

APPL 2:

Signum® 3:

CLASS: 3.6.

Once the limit is exceeded by the load, initialization can begin.

Once the application is initialized, a weight value below the minimum load is designated Class 0; no class is displayed.

The minimum load required for automatic taring of the container weight on the platform (first weight), or for automatic printout of results, is configured in Setup under:

APPL:  3.5.

Signum® 3:

APPL: M.WEIGH: 3.5.

You can choose from the following 10 levels for this setting:

- 1 digit
- 2 digits
- 5 digits
- 10 digits
- 20 digits
- 50 digits
- 100 digits
- 200 digits
- 500 digits
- 1000 digits

The “digits” here refer to the scale intervals in the connected weighing platform. If the interval of the connected platform is 1 g, for example, and 1000 digits are required, you must place at least 1000 g (=1000 intervals =1000 digits) on the weighing platform for the first class to activate autotaring or autoprint.

**Display**

The result of a given measurement is shown as either a weight value or a class number.

- Weight display:  
The current weight is shown in the measured value line and the current class in the text lines.
- Display of classes:  
The current class is shown in the measured value line, and the current weight in the text lines.

**Digital I/O Interface**

The Classification application supports the digital input/output-interface.

There are 4 control lines, or outputs, which are activated as follows (see also the diagram below):

- With 3 classes:
  - Class 1
  - Class 2
  - Class 3
  - Set
- With 5 classes:
  - Classes 1/2
  - Classes 2/3/4
  - Classes 4/5
  - Set

In Setup, under:

APPL:  4.7.

Signum® 3:

APPL 2:

CLASS: 4.7.

you can define whether these control ports are

- switched off
- always on
- on at stability

The “SET” output normally changes its voltage level when the current weight exceeds the minimum load. Alternatively, you can assign the “Ready for use” function to this port. Configured in Setup under:

APPL:  4.3.

Signum® 3:

APPL 2:

CLASS: 4.3.

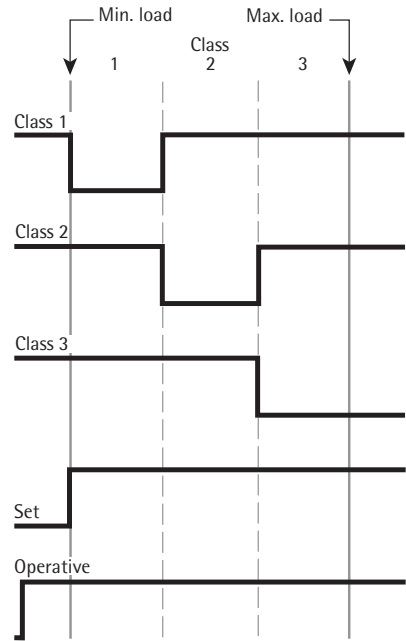

Digital I/O Interface  
Control lines when working with 3 classes

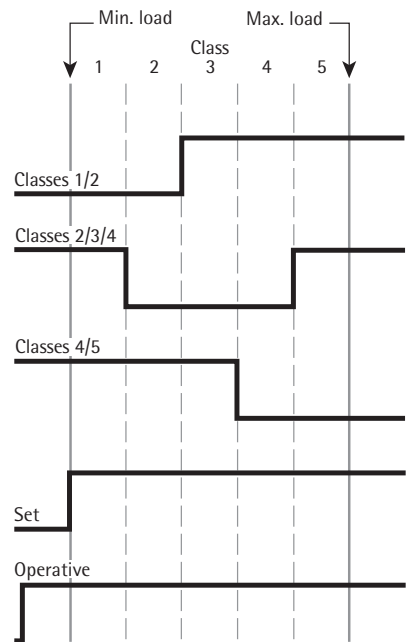

Digital I/O Interface  
Control lines when working with 5 classes

**Example:**

Defining three classes.

Settings (different from the factory settings):

Setup: Application 2: Classification

Setup: Printout, PRTPROT 7.6, then select the menu line items of your choice

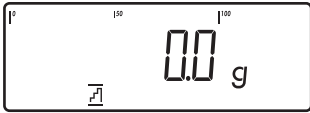

OK



1.) Begin input of class delimiters

1 1 0



2.) For Signum® 3 only:  
Enter the upper limit for Class 1 using the keypad (in this example, 110 g)

OK



3.) Save the upper limit for Class 1

1 3 0

4.) For Signum® 3 only:  
Enter the upper limit for Class 2 using the keypad (in this example, 130 g)

OK

5.) Save the upper limit for Class 2

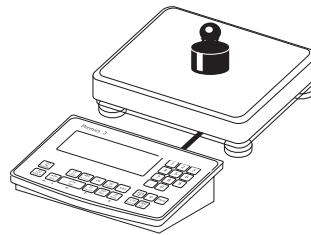
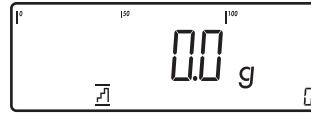

6.) Place the sample on the weighing platform



Read the result



7.) Print the results  
Note: If automatic printout of results is enabled, you do not need to press the  key. The results are printed automatically.

```
Lim1 + 0.110 kg
Lim2 + 0.130 kg

G#   + 0.118 kg
T    + 0.000 kg
N    + 0.118 g
```

Configured printout:  
see page 81

```
Class      2
-----
```

## Totalizing Application $\Sigma$

With the Totalizing application, you can add weight values to the totalizing memory.

In addition to weight values, the number of separate values added to memory is also saved (transaction counter).

### Characteristics

- Totalize up to 999 individual weights

Save values automatically:

- Simultaneous saving of net values and calculated values (if available). Configured in Setup under:

*APPL:  $\Sigma$ : 3.16.*

*Signum® 3:*

*APPL 3:*

*TOTALIZ: 3.16.*

- Save weight values and calculated values from either Application 1 (for example, Counting, Weighing in Percent) or Application 2 (Checkweighing). Configured in Setup under:

*APPL:  $\Sigma$ : 3.22.*

*Signum® 3:*

*APPL 3:*

*TOTALIZ: 3.22.*

- Current transaction number displayed in the text lines (indicating the transactions already added)

- Weighing in up to a defined target, with the totalization memory content + current weight displayed in the text lines

- Save weight values manually or automatically

- Accurate calculation of total of weight values from two weighing platforms

- Activate Info mode via the **[Info]** key

- Automatic printout when value saved

- Automatic taring of container weight. Configured in Setup under:

*APPL:  $\Sigma$ : 3.7.*

*Signum® 3:*

*APPL: A.TARE: 3.7.*

- Incomplete totalizing routines saved in battery-backed memory after Signum® 3 is switched off. Configured in Setup under:

*APPL:  $\Sigma$ : 3.8.*

*Signum® 3:*

*APPL: A.START: 3.8.*

Signum® 3 only:

- You can assign different functions to the **[CF]** key for deleting applications. When you clear applications, you can delete either the data stored for all applications or just the data stored for the active application. Configured in Setup under:  
*APPL: SEL.CF: 3.24.*  
(Sel. CF function key **[CF]** in applications)

- Tare function:

1) If you store a tare (weight value) by pressing the **[T $\leftrightarrow$ ]** key, you can later enter a value manually. The value you enter is added to the stored tare value. Setting: menu code 3.25.1 (factory setting)

2) A value entered manually overwrites a stored tare value (weight value).

If you enter a value manually, a tare value (weight value) stored later overwrites the manually entered value.

Setting: menu code 3.25.2

Configured in Setup under:

*APPL:  $\Sigma$ : 3.25. ;*

*Signum® 3*

*APPL: TARE.F: 3.25.*

- Restore factory default settings.

Configured in Setup under:

*APPL:  $\Sigma$ : 9.1.*

*Signum® 3:*

*APPL: DEF.APP: 9.1.*

A totalizing memory is available for adding individual net and gross values. Weight values can be saved to the totalizing memory either manually or automatically. Configured in Setup under:

*APPL:  $\Sigma$ : 3.16.*

*Signum® 3:*

*APPL 3:*

*TOTALIZ: 3.16.*

- Save value manually by pressing the **[OK]** key.

The value taken from the active platform is added to the value already saved in totalization memory and the transaction counter value is increased by one.

When a value is added manually, the program does not check whether the platform has been unloaded since the last time the **[OK]** key was pressed.

- Value saved automatically when the weighing platform is stable and the defined minimum load is exceeded. If the defined minimum load is not exceeded, you can save the item manually by pressing the **[OK]** key. Regardless of these settings, the current value cannot be saved automatically unless the platform is unloaded before the next sample is placed on it. The weighing platform is considered to be unloaded when the load is less than 50% of the minimum load.

The number of items added to memory is displayed in the text lines.

Press the **[CF]** key to clear the totalizing memory. A printout is automatically generated.

With 2 weighing platforms connected, you can add values from both platforms to the totalizing memory. The displayed result is accurately calculated in the active weight unit.

Example: When you add 1243 g (determined on a weighing platform with three decimal places) to 1400 g (determined on a platform with 1 decimal place), the display shows 2643 kg.

**Preparation**

- Switch on the scale: Press the **(ON)** key
- While all segments are lit, press the **(←T→)** key
- Select the Setup menu: Press the **(Fn)** key repeatedly until *APPL* is displayed
- Confirm *APPL*: Press the **(←T→)** key
- Select the Totalizing application: Press the **(Fn)** key repeatedly and confirm with the **(←T→)** key

## Totalizing Application Parameters

3. 6.	Minimum load for autosave	
—	3.6.1*	1 digit
—	3.6.2	2 digits
—	3.6.3	5 digits
—	3.6.4	10 digits
—	3.6.5	20 digits
—	3.6.6	50 digits
—	3.6.7	100 digits
—	3.6.8	200 digits
—	3.6.9	500 digits
—	3.6.10	1000 digits
3.16.	Autosave mode	
—	3.16.1*	Off
—	3.16.2	On
3.17.	Individual/Component printout when saved	
—	3.17.1	Automatic printing off
—	3.17.2*	Print the entire standard print configuration every time with the <b>(OK)</b> key
3.22.	Source of data for autosave	
—	3.22.1*	Application 1
—	3.22.2	Application 2
3.23.	Saved value	
—	3.23.1*	Net
—	3.23.2	Calculated
—	3.23.3	Net and Calculated

\* = Factory setting

- Save the settings with the **(←T→)** key and exit Setup: Press the **(→0←)** key several times.

**Minimum load**

The minimum load required for automatic taring of the container weight on the platform (first weight) is configured in Setup under:

*APPL*: Σ: 3.5.

Signum® 3:

*APPL*: M.WEIGH: 3.5.

The minimum amount that a component must weigh before it can be saved in totalizing memory is configured in Setup under:

*APPL*: Σ: 3.6.

Signum® 3:

*APPL* 3:*TOTALIZ*: 3.6.

You can choose from the following 10 levels for this setting:

1 digit  
2 digits  
5 digits  
10 digits  
20 digits  
50 digits  
100 digits  
200 digits  
500 digits  
1000 digits

The “digits” here refer to the scale intervals in the connected weighing platform. If the interval of the connected platform is 1 g, for example, and 1000 digits are required, you must place at least 1000 g (= 1000 intervals = 1000 digits) on the weighing platform for autotaring (only with the “Autotare first weight” option selected).

**Protocol**

In Setup, under:

*APPL*: Σ: 3.17.

Signum® 3:

*APPL* 3:*TOTALIZ*: 3.17.

You can configure whether a printout is generated manually, by pressing **(E)**, or automatically when a weight value is stored in the totalizing memory.

If you select the 3.17.1 menu item, printouts can only be generated manually by pressing the **(E)** key (single printout).

If the 3.17.2 menu item is selected (Print one component), the component record is printed.

The total data record is printed when you clear the totalizing memory (by pressing the **(CF)** key).

**Example:**

Totalizing weight values

Settings (different from the factory settings):

Setup: Application 3: Totalizing

Setup: Printout, PRTPROT 7.6

Setup: Device Parameters: Printout: Printer 1: Select "Component log:

Auto printout", then select the menu line items of your choice PRTPROT: 7.7.

Setup: Printout: Printer 1: Select "Total data record:

Printout as per CF key," then select the menu line items of your choice PRTPROT: 7.8.

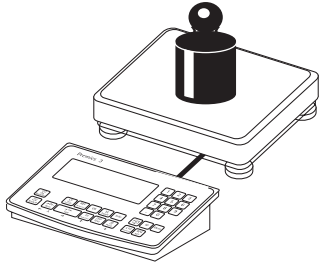

1.) Place the first weight on the weighing platform

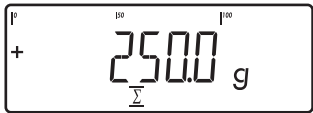

Weight value is displayed

OK

2.) Store first weight value in totalizing memory

G#	+	0.250	kg
T	+	0.000	kg
N	+	0.250	kg
n		1	

Component weight is printed automatically (configured component log)

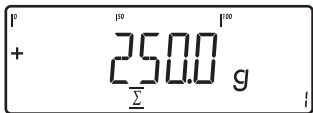

The transaction counter value is increased by one.

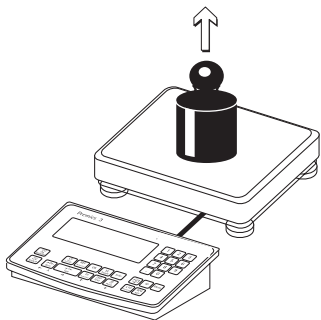

3.) Remove the first weight from the weighing platform

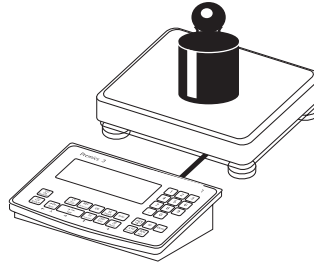

4.) Place the second weight on the weighing platform



Weight value is displayed

OK

5.) Store second weight value in totalizing memory

G#	+	1.346	kg
T	+	0.346	kg
N	+	1.000	kg
n		2	

Component weight is printed automatically (configured component log)

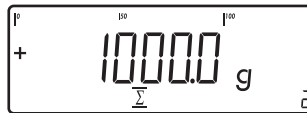

The transaction counter value is increased to two.

F2

6.) Toggle display between individual value and total

CF

7.) End totalizing.



*G	+	1.346	g
*N	+	1.250	g
n		2	
-----			

Configured total data record is printed.

## Net-total Formulation Application

With this application, you can weigh in different components up to a defined total. Each component is saved in the net-total memory.

### Characteristics







- Weigh in up to 999 components in series
- Net-total formulation cannot be combined with a level 1 or level 2 application
- Current component number displayed in the text lines (indicating the component to be added)
- Toggle the display from “component mode” to “additive mode” by pressing the  key
  - Component mode: Display the weight of the component currently on the platform (for 1 second after it is saved; then the platform is tared)
  - Additive mode: Display the weight of all components on the platform (after it is saved, the net weight of the last component added is displayed briefly)
- Toggle to a second weighing platform while weighing on the first
- Activate Info mode via the  key
- Automatic component printout when it is saved. Configured in Setup under:
  - APPL*: : 3. 17.
  - Signum® 3:
  - APPL* 3:
  - NET TOT*: 3. 17.

- Automatic taring of container weight. Configured in Setup under:
  - APPL*: : 3. 7.
  - Signum® 3:
  - APPL*: *A.TARE*: 3. 7.



- Restore factory default settings. Configured in Setup under:
  - APPL*: : 9. 1.
  - Signum® 3:
  - APPL*: *DEF.APP*: 9. 1.

If the 3. 17.2 *MENU* item is selected, the entire component record is printed.  
 If the 3. 17.3 menu item is selected, the following items are generated only once for the first component:  
 blank line, date, time, ID1 through ID4, header lines 1 and 2. For subsequent components, each “component” item (“Comp xx”) is followed by a blank line.



**Preparation**

- Switch on the scale: Press the  key
- While all segments are lit, press the  key
- Select the Setup menu: Press the  key repeatedly until *APPL* is displayed
- Confirm *APPL*: Press the  key
- Selecting the Net-total Formulation Application:  
Press the  key repeatedly and confirm with the  key

Net-total Formulation Application Parameters

3.6.	Minimum load for autosave	
3.6.1*	1 digit	
3.6.2	2 digits	
3.6.3	5 digits	
3.6.4	10 digits	
3.6.5	20 digits	
3.6.6	50 digits	
3.6.7	100 digits	
3.6.8	200 digits	
3.6.9	500 digits	
3.6.10	1000 digits	
3.17.	Individual/Component printout when saved	
3.17.1	Automatic printing off	
3.17.2*	Print the entire standard print configuration every time with the  key	
3.17.3	Print the entire standard print configuration once with the  key	

\* = Factory setting

- Save the settings with the  key and exit Setup: Press the  key several times.

**Minimum load**

The minimum amount that a component must weigh before it can be saved in net-total memory is configured in Setup under:  
*APPL*: : 3.6.  
 Signum® 3:  
*APPL* 3  
*NET TOT*: 3.6.

Once the limit is exceeded by the load, the value can be saved. If the load on platform is too light, the following will occur when you try to save a value:

- The error code *INF 29* is displayed
- The weight is not saved

The minimum load required for automatic taring of the container weight on the platform (first weight) is configured in Setup under:  
*APPL*: : 3.5.  
 Signum® 3:  
*APPL*: *M.WEIGH*: 3.5.



You can choose from the following 10 levels for this setting:

- 1 digit
- 2 digits
- 5 digits
- 10 digits
- 20 digits
- 50 digits
- 100 digits
- 200 digits
- 500 digits
- 1000 digits

The “digits” here refer to the scale intervals in the connected weighing platform. If the interval of the connected platform is 1 g, for example, and 1000 digits are required, you must place at least 1000 g (= 1000 intervals = 1000 digits) on the weighing platform for initialization.

**Net-total Formulation with Two Weighing Platforms**

This mode is used for weighing large and small components at the same time.

It is possible to toggle from the small-component platform to the large-component platform once during a measurement series. Once you toggle to the large-component platform, the  and  keys are available until a component is saved. For example, you can tare a partially-filled container taken from the small-component platform on the large component platform.

The value in component memory on the small-component platform is transferred to the large-component platform and the weight unit is converted, if necessary. The Component and Additive display modes are both available on the large-component platform.

The value read by the active platform is saved in component memory. The displayed result is accurately calculated in the active weight unit.

When you press  to stop a measurement series the tare memories for both platforms are cleared, unless the large-component platform is an SBI instrument, in which case the platform is only tared.

**Example:**

Weighing in 3 components of a formulation recipe.

Settings (different from the factory settings):

Setup: Application 3: Net-total Formulation

Setup: Printout, PRTPROT: 7.7. Printer 1:

Select "Component log: Auto printout", then select the menu line items of your choice

Setup: Printout, PRTPROT: 7.8 Printer 1:

Select "Total data record: Printout as per CF key," then select the menu line items of your choice

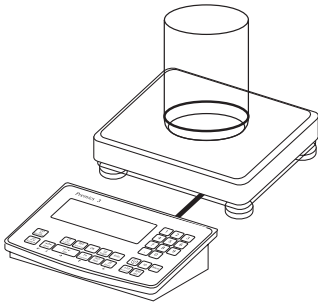

1.) Place empty container on the platform



2.) Tare the scale

Note: If the automatic tare function is enabled, you do not need to press the  key to tare the platform; the tare weight is saved automatically when you place the container on the platform



A prompt to fill and save the first component is shown

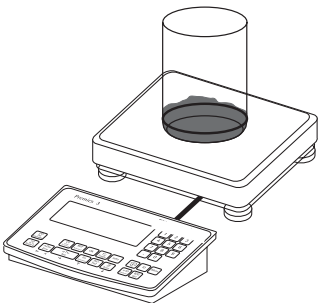

3.) Add the first component to the container (in this example, 1100 g)

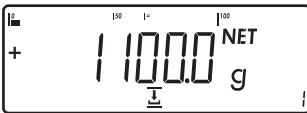

The weight of the first component is displayed



4.) Save the first component weight

Cmp001+ 1.100 kg

The component record is printed automatically



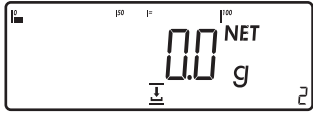

The weighing platform is tared and the component counter value is increased by one. Prompt to fill and save the second component is shown

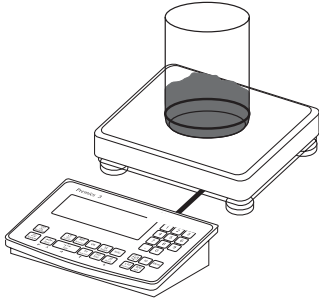

5.) Add the second component to the container (in this example, 525 g)



The weight of the second component is displayed



Cmp002+ 0.525 kg

6.) Save the second component weight

The component record is printed automatically

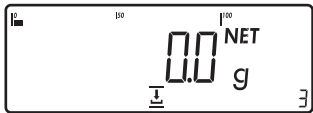

The weighing platform is tared and the component counter value is increased by one. Prompt to fill and save the third component is shown



7.) Toggle to the "additive mode" to display the total weight of all components



The value displayed equals the weight of components added up to now plus the current weight on the platform.

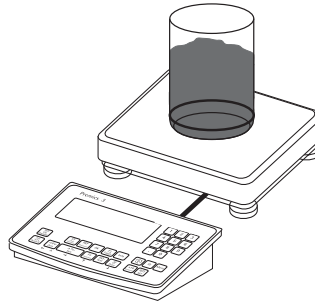

8.) Add the third component to the container until the desired target is reached (in this example, 2000 g).

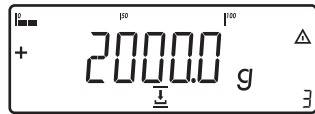

The total weight is displayed



Cmp003+ 0.375 kg

9.) Save the third component weight

The component record is printed automatically

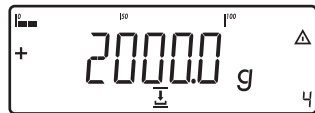

The component counter value is increased by one. Prompt to fill and save the fourth component is shown



10.) End weighing-in operation

n + 3  
Tot. cp+ 2.000 kg  
Cont. T+ 0.296 kg

Results are printed automatically (configured total data record)

Number of components  
Content of component memory  
Content of tare memory (container weight)

**Example: "Portioning" (counting, checkweighing with totalizing)**

Settings (different from the factory settings):  
 Setup: Application parameters: Application 1: Counting (COUNT)  
 Setup: Application parameters: Application 2: Checkweighing (CHECK.WG)  
 Setup: Application parameters: Application 3: Totalizing: Saved value: Net + Calculated (3.23.3)  
 Setup: Application parameters: Application 3: Totalizing: Autosave: On (3.16.2)  
 Setup: Application parameters: Application 3: Totalizing: Source of data: Application 2 (3.22.2)  
 Setup: Printout: PRT PROT 7.8. Printer 1:  
 "Total printout: Print when FN pressed," then select the menu line items of your choice (X.XX.X))



1.) Switch on the scale and enter settings as above



2.) Delete any data from previous operation

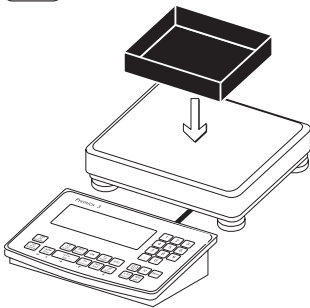

3.) Place empty container on the platform.



4.) Tare the scale

Note: If the automatic tare function is enabled, you do not need to press the key to tare the platform; the tare weight is saved automatically when you place the container on the platform

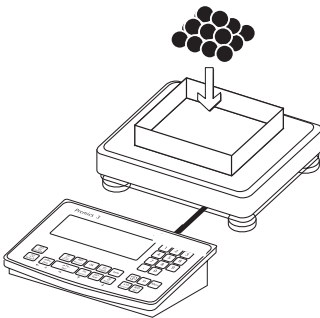

5.) Place a number of parts in the container for the reference quantity (in this example, 10 pcs)



6.) Start calculation of reference sample weight

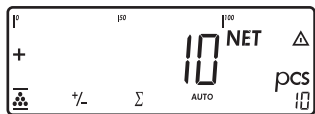

If the weight is too light, an error code is shown in the main display: *INF 29*

Reduce the minimum load setting or increase the reference sample quantity setting and the number of parts in the container

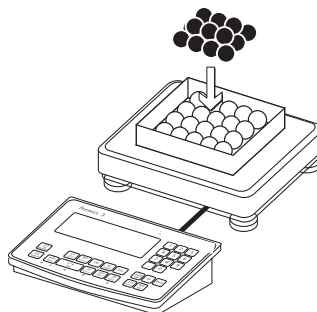

11.) Add desired number of pieces



7.) Toggle to Checkweighing

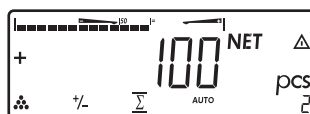
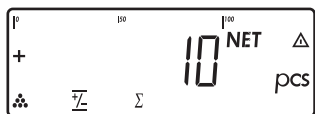

The number of pieces is



8.) Initialize Checkweighing

12.) Unload the scale:  
Remove the samples

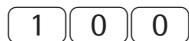

9.) Enter target value, minimum and maximum (in this example, target 100 pieces, minimum 100 pieces, maximum 102 pieces)

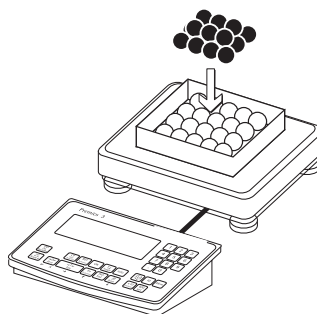

13.) Perform further counting operations as desired

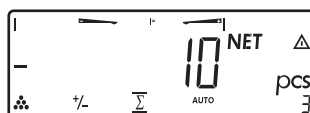
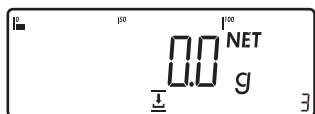
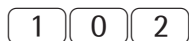
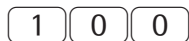

14.) Toggle display from individual value to total



15.) End the portioning options and print the final evaluation



10.) Toggle to Totalizing

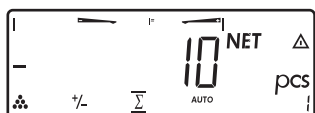

```

-----
nRef +      10 pcs
wRef + 0.001000 kg
Setp +     100 pcs
Min  +     100 pcs
Max  +     102 pcs

n          6
*N   +     0.600 kg
Total +     600 pcs
-----
    
```

Configured printout: Total

## Configuring Printouts

### Purpose

You can configure individual printout formats for each application. Using the total data record for Totalizing and Net-total Formulation applications, you can define which parameters are printed using the **[CF]** key.

In the "Print parameters" Setup menu, single, component and total data records can be configured, which contain the available print items for the respective applications. This should be carried out after setting the applications since some data in the printout is application-dependent.

### Characteristics

- Quantity and extent of printout lists:
  - 6 lists each with a max. length of 30 print items
  - Single printout Printer 1
  - Component printout Printer 1
  - Total data printout Printer 1
  - Single printout Printer 2
  - Component printout Printer 2
  - Total data printout Printer 2
- Single, component and total data records can be configured separately
- Print single printout: **[F]** key  
Auto printout of application when Setup menu is activated:
  - Animal weighing (averaging)
  - Checkweighing
  - Classification
- Signum® 2 and 3 only:
  - Print component printout: Totalizing/Net-total formulation with the **[OK]** key (Setup: Application 3: Totalizing: Printout: Component printout)
- Signum® 2 and 3 only:
  - Print totalizing printout: For selected application Totalizing/Net total formulation with the **[CF]** key
- When switching to another application in Setup, only the application-dependent printout lists are deleted. The other printout lists remain saved.
- Print items can be deleted individually: Press and hold the **[⇨0⇩]** key
- Print items "Form Feed" for record footer:
  - Move to the next label start for printer type: YDP011S: "Label" and YDP04IS, setting "Label, manual form feed"
- ISO/GLP/GMP-compliant printout: The Setup menu configuration under "ISO/GMP-compliant printout" is also active for configured printouts.

### Preparation

- Switch on the scale: Press the **[I/O]** key
- While all segments are lit, press the **[⇨T⇩]** key
- Select Setup: Press the **[Fn]** key repeatedly until **SETUP** is displayed
- Select Config. printout: Press the **[⇨T⇩]** key
- Press the **[Fn]** key repeatedly until **PRTPROT** is displayed
- Press the **[⇨T⇩]** key

**PRTPROT**  
(see page 35 for a detailed menu list)

7	7.4	Header and ID header input
	7.5	Quantity, interface <sup>1)</sup>
	7.6	Standard, interface <sup>1)</sup>
	7.7	Component, interface <sup>1)</sup>
	7.8	Result, interface <sup>1)</sup>
	7.9	Quantity, interface <sup>2)</sup>
	7.10	Standard, interface <sup>2)</sup>
	7.11	Component, interface <sup>2)</sup>
	7.12	Result, interface <sup>2)</sup>
	7.13	ISO/GMP
	7.14	Date without time <sup>1)</sup>
	7.15	Automatic printout after stability
	7.16	Flex print
	7.17	Decimal separator
9	9.1	Factory settings

■ = Signum® 2 and 3 only

- The rows of the protocol list can be called up and activated individually. Example: see under Configuration, menu item 7.6
- The print selection set as active appears with the left selection bar on the display, e.g. gross, tare, net.
  - Extend printout, press the **[⇨T⇩]** key, the selection bar now appears on the right of the display.
  - Select print items using the **[Fn]** key
  - Apply the desired print items by pressing the **[⇨T⇩]** key
  - Press the **[⇨0⇩]** key to change the print selection set as active. The selection bar appears on the left. The required print item is set as active and appears in the printout.

- Print items can be deleted individually from the active printout selection: Press and hold the **[⇨0⇩]** key
- Save the settings with the **[⇨T⇩]** key and exit Setup: Press the **[⇨0⇩]** key several times.

### Additional Functions

- Printing the "Selection" and "List" Settings
  - **LIST**: Print the currently selected list
  - **SELECT**: Print currently selectable items
  - When selection bar is in **LIST** or **SELECT**: Press the **[F]** key

### > Printout (example)

```
INDIV. PRT
  List
=====
Net (N)
Gross (G#)
Tare
Tare (T2/PT2)
Piece count
=====
etc.
```

<sup>1)</sup> Only available if the time module is present.

**Example:**

Standard printout for data output from the Counting application

Settings (different from the factory settings):

Applications: Application 1: Counting

Then access Setup: Printout: Printer 1: "Individual: print by pressing (Fn)"

- Select Setup: Press the (Fn) key repeatedly until *SETUP* is displayed
- Select Config. printout: Press the (→T←) key
- Press the (Fn) key repeatedly until *PRTPROT* is displayed
- Press the (→T←) key



1.) Press the (→T←) key until 7.4 appears in the display

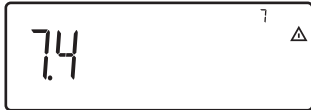

2.) Press the (Fn) key until 7.6 appears in the display



3.) Press the (→T←) key to display the list of print items (active print selection)



4.) Press the (→T←) key to access the selection list



First printout list of selection list



5.) Press the (→T←) key to apply the displayed print items from the selection list to the list of print items.

Or



6.) Press the (Fn) key to go to the possible print items in the selection list.  
Selection of available print items, see *SETUP: PRTPROT* pages 35–36



7.) Press the (Fn) key until ---- appears in the display

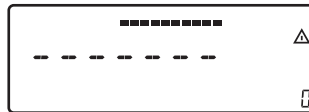

8.) Press the (→T←) key to apply the selection



9.) Press the (Fn) key until *REF.-GEW* appears in the display



10.) Press the (→T←) key to apply the selection

11.) Selecting additional printout items: see previous steps

12.) To complete the selection of print items, press the (→0←) key until *APPL* appears in the display

13.) Press and hold the (→T←) key (2–3 sec) to switch to weighing mode

14.) Carry out weighing and then print

15.) Press the (Fn) key to print the results



Printout example  
-----  
wRef + 0.4000 g

## Product Data Memory for Signum® 3

### Purpose

The product data memory stores initialization data and user data (product and tare values).

### Characteristics

- The product data memory has sufficient capacity for 100 product or tare values.
  - For example, you can store 80 sets of application data and 20 tare values.
- Each memory cell is uniquely identified by a number up to three digits.
- The product data memory can be used with the following applications:
  - Application level 1
    - *WEIGH.*
    - *COUNT.*
    - *NEUTR.M*
    - *ANIM.WG*
    - *PERC.WG*

### Application level 2

- *CHECK.WG*
- *CLASS.*
- Data records can be created, overwritten and individually deleted.
- Data remains stored when the weigher is switched off.

### Functions

Saving product data (in this example, in the Counting application):

- Initialize the application.
- Enter a memory number and press and hold the **[Mem]** key (min. 2 seconds).

Saving preset tare values:

- Allocate preset tare memory.
- Enter a memory number and press and hold the **[Tare]** key (min. 2 seconds).

Activation of saved product or tare values:

- Enter a memory number and press the **[Mem]** key.

Displaying information for a specific product or tare value:

- Enter a memory number and press the **[Info]** key.
- Use the **[Fn]** key to select between *WREF* (average piece weight) and *NREF* (quantity).
- Use the **[→T←]** key to scroll the displayed value to the right.
- Activate the displayed memory by pressing the **[Mem]** key.
- Delete the displayed memory by pressing and holding the **[CF]** key (min. 2 seconds).
- Exit the mode by pressing the **[CF]** key.

Displaying information for all product or tare memories:

- Press the **[Mem]** key to display the first memory number.
- Press the **[Fn]** key to scroll through in lexical order (e.g. 1, 3, 333, 4, ...).
- Press the **[Mem]** key to activate the selected memory number.
- Display the saved product values using the **[Info]** key.
- Press and hold the **[CF]** key to delete the selected memory number.
- Exit the mode by pressing the **[CF]** key.

Deleting a specific memory number:

- Enter a memory number and press and hold the **[CF]** key.

### Example:

Using the Counting application with a stored average piece weight.  
Settings (different from the factory settings):  
Setup: Application parameters:  
Application: Counting (*COUNT.*)

Saving the average piece weight:

- Initialize the application.
- Determine the average piece weight using one of the methods described above.
- Enter the memory cell number using the keypad, and press and hold the **[Mem]** key (min. 2 Seconds).

Loading the average piece weight or reference sample quantity:

- Enter the memory cell number and press the **[Info]** key.
- Use the **[Fn]** key to select between *WREF* (average piece weight) and *NREF* (quantity).
- Press the **[→T←]** key repeatedly to scroll the displayed value to the right.
- Activate the displayed memory by pressing the **[Mem]** key.
- Delete the displayed memory by pressing and holding the **[CF]** key (min. 2 seconds).
- Exit the mode by pressing the **[CF]** key.

Overwriting data in memory cell:

- To save a new average piece weight in a memory cell already in use, enter the desired memory cell number using the keypad and press and hold the **[Mem]** key (min. 2 seconds). The previous average piece weight is overwritten.

Deleting an average piece weight:

- Enter the memory cell number of the average piece weight to be deleted and press the **[Info]** key.
- Delete the displayed value by pressing and holding the **[CF]** key (min. 2 seconds).

## Data Interface

For COM1 (25-pin D-Sub female connector), for model SIWSDCS/SIWSBBS with round socket in the model SIWAEDG over cable gland\*

COM1	All Signum® models	Signum® 2 and 3 only
Standard: RS-232 SBI   XBPI protocol	PC with serial RS-232 input port  Printer: YDP04IS YDP02IS YDP12IS YDP20-OCE  External Alibi memory: YAM01IS  External Bluetooth adapter: YBT01 Second display: YRD02Z USB adapter cable for connecting a PC via USB: YCC01IS Digital in (TTL/ 5V)	Red-green-red display YRD14Z (uses digital control lines)  Digital control lines (TTL/ 5V) <;=;set;> to relay box YSB01  Additional platform with RS-232 interface SMA   XBPI protocol
Option: RS-232 Option A31: "Clock"	As with standard RS-232 interface, but includes date/time	
Option: RS-232 Option A32: "connectivity"	As with RS-232 "Clock," additional connection for barcode scanner (YBR02PS) or standard PC keyboard with PS/2 plug	
Universal in: print/ tare	Print/Tare key function	

### For UNICOM

Connector:

for RS-232/ RS-422/ RS-485 analog output/ digital I/O: 25-pin D-Sub female connector, for model SIWSDCS/SIWSBBS with round socket\*

Ethernet: RJ-45 socket

Profibus: D-Sub 9 connector

UNICOM (optional)

RS-232 Option A1, YD001SW-232	PC with serial RS-232 input port, SBI/XBPI protocol External Alibi memory: YAM01IS External Bluetooth adapter: YBT01 Second display: YRD02Z USB adapter cable for connecting a PC via USB: YCC01-USBM2 Second weighing point: scale with RS-232 data output Second weighing point: IS platform with optional RS-232 data output Second weighing point for analog platform (e.g. Combics platform CAP*) via YCO02IS-OCE transmitter
RS-422 Option A2, YD001SW-485/422	Point-to-point connection with SBI/XBPI or SMA protocol
RS-485 Option A3, YD001SW-485/422	Network up to 32 weighing instruments over XBPI bus Additional IS platform with standard RS-485 data output
Analog output Option A9, YD001SW-A0	Controllers with analog input
Dig. 5 In/5 OUT Option A5, YD001SW-DIO	For connecting the Signum scale to controllers Digital IN: Voltage: 0-30 V DC Current: 1-2 mA Digital OUT: Voltage: ≥30 V DC Current: 100 mA For specific signals, please refer to the detailed descriptions of the options
Ethernet Option B9, YD001SW-ETH	Office or production area network
Profibus Option B1, YD001SW-DP	Devices with a Profibus DP field bus

\* For model SIWSDCS/SIWSBBS with a round connector and for SIWAEDG you will need a corresponding adapter cable. Contact your Minebea Intec dealer for more information.

### Pin Assignment Chart

COM1 and UniCOM female connectors:  
Round socket with screw lock hardware  
for model  
SIWSDCS/SIWSBBS, stainless steel  
version.

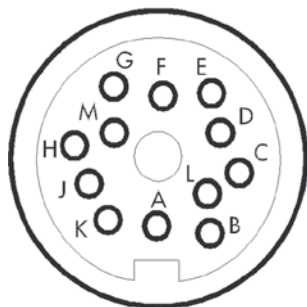

Front view

#### COM1 pin assignments

Round socket with screw lock hardware

- Pin A: Control output: "lighter"
- Pin B: Data output (TxD)
- Pin C: Data input (RxD)
- Pin D: Data terminal ready (DTR)
- Pin E: Internal ground (GND)
- Pin F: +5 V
- Pin G: Control output: "heavier"
- Pin H: Clear to send (CTS)
- Pin J: Control output: "equal"
- Pin K: Universal switch
- Pin L: Control output "set"
- Pin M: +12 V

#### Standard PS/2 pin assignment for SIWABBP, SIWSBBP,

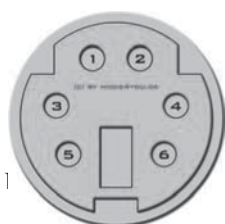

- Pin 1: Keyboard\_CLK
- Pin 2: Keyboard\_DATA
- Pin 3: Not used
- Pin 4: Internal ground (GND)
- Pin 5: +5 V
- Pin 6: Not used

For SIWDCP\* appl. level 2 and higher

### Pin Assignment Chart

COM1 female connectors:  
25-pin D-Submini female connector  
DB25S for model:  
SIW\*DCP\*.../SIW\*BBP...

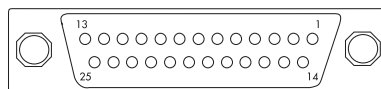

#### COM1 pin assignments

- Pin 1: Shield
- Pin 2: Data output (TxD)
- Pin 3: Data input (RxD)
- Pin 4: Internal ground (GND)
- Pin 5: Clear to send (CTS)
- Pin 6: Internally connected
- Pin 7: Internal ground (GND)
- Pin 8: Internal ground (GND)
- Pin 9: Not used
- Pin 10: Not used
- Pin 11: +12 V for printer
- Pin 12: RES\_OUT\
- Pin 13: +5 V (on/off for barcode scanner)
- Pin 14: Internal ground (GND)
- Pin 15: Universal switch
- Pin 16: Control output: "lighter"
- Pin 17: Control output: "equal"
- Pin 18: Control output: "heavier"
- Pin 19: Control output "set"
- Pin 20: Data terminal ready (DTR)
- Pin 21: Ground power supply (GND)
- Pin 22: Not used
- Pin 23: Not used
- Pin 24: Power supply +15...25 V (peripherals)
- Pin 25: +5 V

Required interface connector  
(Recommended):  
25-pin D-Submini (DB25)  
with shielded cable clamp assembly and  
shield plate (Amp type 826 985-1C) and  
fastening screws  
(Amp type 164868-1)

#### Connecting a second weighing platform:

On Signum® 2 and 3 models, you can  
connect a second weighing platform.  
You can use both the COM1 and  
UniCOM port.\*

COM1 is operated in the RS-232 mode.  
A second weighing platform can use  
the following operating modes:

- SBI
- XBPI-232 (factory setting)
- ADC-232

UniCOM can be operated in either  
RS-232 or RS-485 mode. A second  
weighing platform can use the  
following operating modes:

- SBI (RS-232 mode)
- XBPI-232 (RS-232 mode)
- ADC-232 (RS-232 mode)
- IS-485 (RS-485 mode, xBPI mode,  
factory setting)
- ADC-485 (RS-485 mode)
- 2. ADU via additional interface  
(menu: *COMSPEC*)

### Pin Assignment Chart SIWAEDG

COM1 connection:

The COM1 interface is compatible with  
the standard Signum COM1 in function;  
however, it uses a screw terminal.



PIN	Function
1	CTS
2	DTR
3	RxD
4	TxD
5	GND
6	UNIV_IN
7	MIN
8	PAR
9	MAJ
10	SET
11	LOAD_Printer
12	RESET_OUT
13	GND
14	GND
15	5V_OOOUT
16	5V_SWITCH
17	KBD_DATA
18	KBD_CLK
19	SHLD
20	LINE_OUT

\* Not possible for SIWAEDG



Cabling Diagram (Adapter Cable for PC)

Indicator

PC

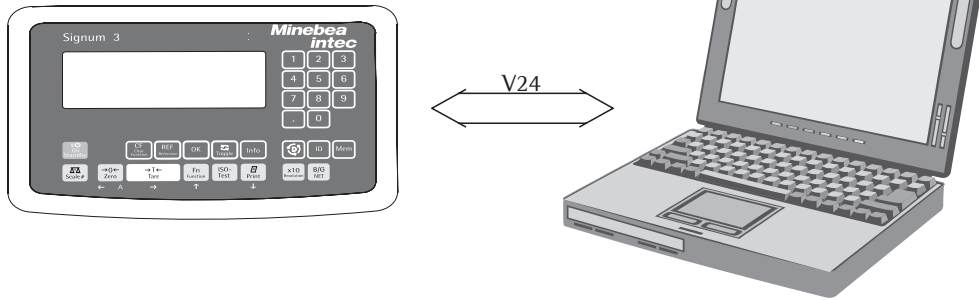

Waage 25-pin Stecker	Buchse Computer 9 pin
----------------------------	-----------------------------

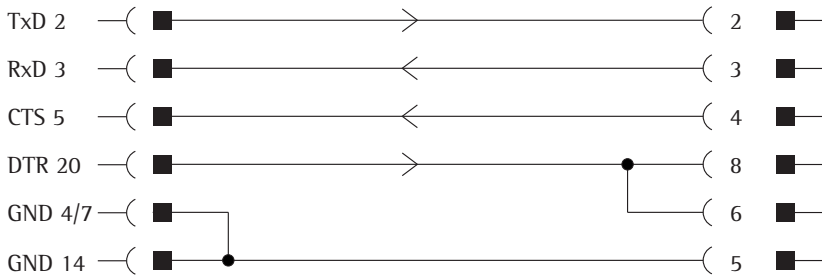

Waage 25-pin Stecker	Buchse Computer 25 pin
----------------------------	------------------------------

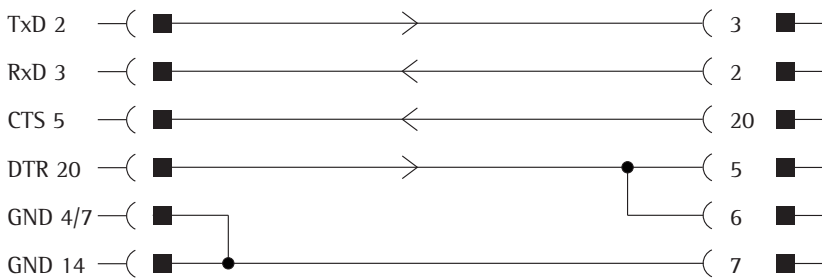

Cable type: AWG 24 specification

## Configuring the Data Interface as a COM Port (D<sub>AT</sub>PROT)

You can configure the interface as a COM port in either COM1 or UniCOM, “Data Protocol” (D<sub>AT</sub>PROT) menu item.

### SBI communication

This is a simple ASCII interface. Data output is configured under menu items 6.1 and 6.3:

- Manual output of displayed value with or without stability (menu items 6.1.1 and 6.1.2)
- Automatic output of displayed value with or without stability (menu items 6.1.4 and 6.1.5) at intervals defined by display updates. The number of display intervals is set in menu item 6.3.
- Output of a configurable printout. Output is linked to the “Printouts” menu item (P<sub>RT</sub>PROT), (see page 81 “Configuring Printouts”)

If you do not activate and configure a user-definable data record, the printout simply contains the current value displayed on the display and control unit (weight with unit, calculated value, alphanumeric display).

### SMA communication

Standardized communications protocol of the Scale Manufacturers Association

## Data Input Format (Commands)

You can connect a computer to your scale to send commands controlling weighing instrument functions and applications via the interface port.

All commands use the same data input format. They start with the ESC character (ASCII 27) and end with a carriage return (CR; ASCII 13) and a line feed (LF; ASCII 10). The total length of a command is anywhere from 4 characters (1 command character between the start and end described above) to a max. of 7 characters (4 command characters).

The commands listed in the following table must each be supplemented with ESC ... CR LF.

Example: The command character for output is “P” (“output to Port”).

To trigger this command, send the string: “ESC P CR LF”.

Command	Meaning
K	Weighing mode 1
L	Weighing mode 2
M	Weighing mode 3
N	Weighing mode 4
O	Block keys
P	Send display value to data interface
R	Unblock keys
T	Taring and zeroing (Combined Tare function)
f3_	Zero (see also the “kZE_” command)
f4_	Tare without zeroing (see also the “kT_” command)
kF1_	F1: Trigger (Fn) key function
kF2_	F2: Trigger (CF) key function (Signum® 2 + 3 models only)
kF3_	F3: Trigger (REF) key function (Signum® 2 + 3 models only)
kF4_	F4: Trigger (OK) key function (Signum® 2 + 3 models only)
kF5_	F5: Trigger (S) key function (Signum® 2 + 3 models only)

Command	Meaning
kF6_	F6: Trigger (Info) key function (Signum® 2 + 3 models only)
kF7_	(ID) key *
kF8_	(G) key *
kF9_	(Mem) *
kCF_	CF: Trigger (CF) key function (Signum® 2 + 3 models only)
kP_	Trigger (E) key function Output to printer port
kT_	Trigger (T) key (tare)
kNW_	Trigger (Δ) key function (toggle the weighing platform) **
kZE_	Trigger (0) key function (zero the instrument)
x1_	Output model designation of active weighing platform. Example: »LP6200S-0C«
x2_	Output serial number of active weighing platform. Example: “0012345678”
x3_	Output software version of active weighing platform. Example: “00-20-04”
z1_	Input: printout header 1
z2_	Input: printout header 2
txx...x_	xx...x: Input text for main display. Length corresponds to input.

The ASCII code for the “underline” character (“\_”) is 95.

Format for entering printout header lines: “ESC z x a ... a \_ CR LF” with x = 1 or 2 and a ... a: 1 to 20 characters for header x, followed by the underline, CR and LF characters.

\* Only Signum 3

\*\* Only Signum 2+3

## Data Output Format

Each line in a print job can contain up to 22 characters (up to 20 printable characters plus two control characters). The first 6 characters, called the “data header”, identify the subsequent value. You can suppress the header under menu item 7.2 in the “Printouts” menu; in this case, the print job has up to 16 characters (up to 14 printable characters plus two control characters).

Examples:

	+	235 pcs	Without header
Qnt	+	235 pcs	With header

Display segments that are not activated are output as spaces. Values with no decimal point are output without a decimal point.

### Data Output Format with 16 Characters (without Data Header)

#### Normal Operation:

Pos.	1	2	3	4	5	6	7	8	9	10	11	12	13	14	15	16
		+	*	A	A	A	A	A	A	*	E	E	E	CR	LF	
or		-	*	A	A	A	A	A	A	*	E	E	E	CR	LF	
or		*	*	*	*	*	*	*	*	*	*	*	*	*	CR	LF

- +-: Plus or minus sign
- \*: Leerzeichen
- A: Digit or letter (max. 7 characters plus decimal point)
- E: Unit symbol (1-3 letters followed by 2-0 spaces)
- CR: Carriage return
- LF: Line feed

#### Special Codes:

Pos.	1	2	3	4	5	6	7	8	9	10	11	12	13	14	15	16
		*	*	*	*	*	*	*	-	-	*	*	*	*	*	CR LF
or		*	*	*	*	*	*	*	H	*	*	*	*	*	*	CR LF
or		*	*	*	*	*	*	*	H	H	*	*	*	*	*	CR LF
or		*	*	*	*	*	*	*	L	*	*	*	*	*	*	CR LF
or		*	*	*	*	*	*	*	L	L	*	*	*	*	*	CR LF
or		*	*	*	*	*	*	*	C	*	*	*	*	*	*	CR LF

- \*: Space
- : Final readout
- H: Overload
- HH: Overload in checkweighing
- L: Underweight
- LL: Underweight in checkweighing
- C: Adjustment

### Error Message:

Pos.	1	2	3	4	5	6	7	8	9	10	11	12	13	14	15	16
		*	*	*	E	r	r	*	*	#	#	*	*	*	*	CR LF
or		*	*	*	E	r	r	*	*	#	#	#	*	*	*	CR LF

- \*: Space
- #: Error code number (2 or 3 digits)

### Example (output of weight value of +1255.7 g):

Pos.	1	2	3	4	5	6	7	8	9	10	11	12	13	14	15	16
		+	*	*	*	1	2	5	5	.	7	*	g	*	*	CR LF

- Position 1: Plus +, or minus – or space
- Position 2: Space
- Positions 3-10: Weight value with decimal point; leading zeros are output as spaces.
- Position 11: Space
- Positions 12-14: Characters for unit of measure or space
- Position 15: Carriage return
- Position 16: Line feed

### Data Output Format with 22 Characters (with Data Header)

#### Normal Operation:

Pos.	1	2	3	4	5	6	7	8	9	10	11	12	13	14	15	16	17	18	19	20	21	22	
		K	K	K	K	K	+	*	A	A	A	A	A	A	A	*	E	E	E	CR	LF		
or		K	K	K	K	K	-	*	A	A	A	A	A	A	A	*	E	E	E	CR	LF		
or		*	*	*	*	*	*	*	*	*	*	*	*	*	*	*	*	*	*	*	*	*	CR LF

- K: ID code character, right-justified with spaces
- +-: Plus or minus sign
- \*: Space
- A: Digit or letter (max. 7 characters plus decimal point)
- E: Unit symbol (1 to 3 letters followed by 2-0 spaces)
- CR: Carriage return
- LF: Line feed

#### Special Codes:

Pos.	1	2	3	4	5	6	7	8	9	10	11	12	13	14	15	16	17	18	19	20	21	22	
		S	t	a	t	*	*	*	*	*	*	*	*	*	*	-	-	*	*	*	*	*	CR LF
or		S	t	a	t	*	*	*	*	*	*	*	*	*	*	H	*	*	*	*	*	*	CR LF
or		S	t	a	t	*	*	*	*	*	*	*	*	*	*	H	H	*	*	*	*	*	CR LF
or		S	t	a	t	*	*	*	*	*	*	*	*	*	*	L	*	*	*	*	*	*	CR LF
or		S	t	a	t	*	*	*	*	*	*	*	*	*	*	L	L	*	*	*	*	*	CR LF
or		S	t	a	t	*	*	*	*	*	*	*	*	*	*	C	*	*	*	*	*	*	CR LF

- \*: Space
- : Final readout
- H: Overload
- HH: Overload in checkweighing
- L: Underweight
- LL: Underweight in checkweighing
- C: Adjustment

**Error Message:**

```
Pos. 1 2 3 4 5 6 7 8 9 10 11 12 13 14 15 16 17 18 19 20 21 22
      S t a t * * * * * E r r * * # # * * * * C R L F
or   S t a t * * * * * E r r * # # # * * * * C R L F
```

\*: Space

#: Error code number (2 or 3 digits)

**ID Code Characters:**

Character K	Meaning
G#	Gross value
N	Net value
T	Application tare memory 1
T2	Application tare memory 2
Diff	Difference from calibration value
Targ.	Exact adjustment weight value
Nom.	Exact calibration weight for SBI protocol output
nRef	Reference sample quantity
pRef	Reference percentage
wRef	Reference piece weight
Qnt	Result from Counting (piece count) and Neutral Measurement applications
mDef	Target value for animal weighing
x-Net	Animal weighing results
Setp	Target value for checkweighing
Diff.W.	Absolute difference (e.g. in kg) for checkweighing
Lim	Deviation in % in Checkweighing
Max	Upper tolerance for checkw.
Min	Lower tolerance for checkw.
Stat	Status
Classx	Classification
Limx	Class limit
D	Percentage (as loss)
Prc	Percentage (as residue)
Wxx%	Reference percentage weight
Cmpxxx	Component xxx
Cont.T	Contents of the tare memory in Net-total Formulation
S-Comp	Total of initial weighings for Net-total Formulation
PT2	Preset tare
n	Transaction counter
*G	Sum of gross weights in Totalizing
*N	Sum of net weights in Totalizing
Ser.no	Serial number of the platform or indicator

**Example (output of weight value of +1255.7 g):**

```
Pos. 1 2 3 4 5 6 7 8 9 10 11 12 13 14 15 16 17 18 19 20 21 22
      G # * * * * + * * * 1 2 5 5 . 7 * g * * C R L F
```

Positions 1-6: ID code, right-justified with spaces

Position 7: Plus +, or minus - or space

Position 8: Space

Positions 9-16: Weight value with decimal point; leading zeros are output as spaces.

Position 17: Space

Positions 18-20: Characters for unit of measure or space

Position 21: Carriage return

Position 22: Line feed

△ If the weight value is output with 10-fold increased resolution, this value is not permitted to be printed or saved in a weighing instrument operated in legal metrology in the SBI mode. In this case, the unit symbol is not included with output.

**Configuring the Data Interface as a Printer Port (PRINTER)**

You can connect one or two strip printers or one or two label printers to the Signum®. Configure the COM1 and UniCOM interfaces as printer ports under the *PRINTER* menu item.

There are several actions that generate the command for outputting data to the printer port:

- Pressing the  key. If the operating menu is active, all menu settings under the active menu level are printed.
- Upon receipt of the "Esc k P \_" SBI command. For details, see the section entitled "Data Input Format" in this chapter.
- In some applications, pressing a given key (e.g., to save a value or start a routine) also generates a print command. In this case, a configurable printout is generated with application-specific data.

The ☉ and ☐ symbols are displayed when data is being output to the printer port.

## Automatic Data Output (SBI)

You can have the weight readout printed automatically<sup>1)</sup>. This printout can be generated after a certain number of display updates<sup>2)</sup>. You can also configure whether or not the auto-print function is dependent on the stability of the scale<sup>3)</sup>. The display update frequency depends on both the scale model and the operating status.

Examples:

N	+	153.00 g	Net weight
Stat			Display blank
Stat	L		Display underload
Stat	H		Display overload

“Data output” setting:

1) 3) “Automatic, without stability”

or

“Automatic with stability.”

Factory setting: Manual after stability;  
i.e., automatic data output function off.

2) Time-dependent automatic data output:

Interval: 1, 2, 10 or 100 display updates

Factory setting: 1 display update

### Signum® 2 and 3 only External Keyboard Functions (PC Keyboard)

Configuration

*SETUP: BARCODE: EXT.KEYB*

The alphanumeric key codes implemented here are specific to the German keyboard layout. The following alphanumeric characters are used (some require “Shift” key):  
a - z, A - Z, 0 - 9, space, ,, \ + ' < > / \* \$ @ % / (); = : \_ ? \*

Function keys:

PC keyboard	Signum® 2 and 3
F1	key
F2	key
F3	key
F9	key
F10	Press and hold : Info function
F11	key
F12	key
Print	key
POS 1	key
Backspace	key
ESC	key

## GMP-compliant Printouts

When the corresponding menu item is active, the printout is bracketed by a GMP header and a GMP footer (GMP: “Good Manufacturing Practice”).

The GMP header precedes the first measured result. The GMP footer is printed after the last result in a series of measurements (“GMP-compliant printout always for several application results,” menu item 7.13.3).

To end a series of measured results, press and hold the  $\overline{E}$  key. In this case, the  $\overline{E}$  symbol is displayed after the GMP header is printed and remains in the display until the GMP footer is printed.

If you toggle to a different platform (Signum<sup>®</sup> 2 and 3 only) while a GMP printout of several measured results is being generated (menu item 7.13.3), the GMP footer for the platform used up to that point is generated when you press the  $\overline{AA}$  key. The GMP header for the other platform is included on the next printout generated.

A GMP-compliant printout is generated automatically at the conclusion of calibration/adjustment, linearization routines, as well as when you set or clear a preload.

Three examples of GMP headers and one example of a footer are shown in the following. On Signum<sup>®</sup> 1 models, the “date and time” line is not included.

Weighing platform WP 1:

```
-----
14.01.2017    09:43
Type          SIWR
Ser.no.       12345678
Vers.         1.1007.12.1
BVers.        01-25-01
-----
```

```
Dash line
Date/Time 1)
Signum® Type
Signum® Serial no.
Software version of application
Software version of basic version
Dash line
```

```
-----
14.01.2017    09:45
Type          SIWR
Ser.no.       12345678
Vers.         1.1007.12.1
BVers.        01-25-01
Type          IS12000S
Ser.No        12345678
-----
```

```
Weighing platform WP 2 (xBPI protocol): 2)
Dash line
Date/Time 1)
Signum® Type
Signum® serial no.
Software version of application
Software version of basic version
Platform type
Platform serial no.
Dash line
```

```
-----
14.01.2017    09:45
Type          SIWR
Ser.no.       12345678
Vers.         1.1007.12.1
BVers.        01-25-01
Type          SBI
-----
```

```
Weighing platform WP 2 (SBI protocol): 2)
Dash line
Date/Time 1)
Signum® Type
Signum® serial no.
Software version of application
Software version of basic version
(Platform type)
Dash line
```

```
-----
14.01.2017    09:45
Name:
-----
```



```
GMP footer:
Dash line
Date/Time 1)
Field for signature
Space line
Dash line
```

<sup>1)</sup> Only if clock module is available

<sup>2)</sup> Only for Signum<sup>®</sup> 2 and 3 display and control units

## Error Messages

Error messages are shown in the main display. *ERROR* messages are shown permanently. *INFORMATION* messages are shown for 2 seconds. After this the program automatically returns to the weighing mode.

Display	Cause	Solution
<i>ERR 101</i>	Key is stuck Key pressed when switching on the device	Release key or contact your local Service Center
<i>ERR 320</i>	Operating program memory faulty	Contact your local Service Center
<i>ERR 335</i>	Verified weighing platform not compatible with the connected terminal	Connect a compatible weighing platform
<i>ERR 340</i>	Operating parameter (EEPROM) defective	Turn the scale off and then on again. If the error code Err340 is still displayed, please contact your local Service Center
<i>ERR 341</i>	RAM has lost data Battery is empty	Leave the scale connected to power for at least 10 hrs.
<i>ERR 343</i>	Loss of data in the memory area for transaction numbers in external alibi memory	Contact your local Service Center
<i>ERR 2627</i>	The time entered or stored in the Alibi memory is incorrect	Set output format correctly
<i>INF 01</i>	Data output not compatible with output format	Set output format correctly
<i>INF 02</i>	Adjustment condition was not met e.g. not tared or weighing pan loaded	Do not carry out adjustment until after 0 display Unload scale Tare using the  key
<i>INF 03</i>	Adjustment could not be completed within a certain time.	Allow to warm up again and repeat the adjustment process
<i>INF 06</i>	Built-in calibration weight defective *	Contact your local Service Center
<i>INF 07</i>	Last function not allowed in scales verified for legal use	Contact your local Service Center for information on changing settings
<i>INF 08</i>	The load on the scale is too heavy to enable zero positioning	Check your configuration to ensure that "Zero at power on" (1.12) is set
<i>INF 09</i>	Taring is not possible when the scale gross weight is < zero	Zero the scale
<i>INF 10</i>	Tare key is blocked when there is data in the tare memory	The data stored for the application program must be deleted before taring.
<i>INF 22</i>	Error in storing reference value, heavier weight on the weigher	Load is too light, place a
<i>INF 23</i>	Error in initializing an application	Contact your local Minebea Intec Service Center
<i>INF 29</i>	Minimum load not reached	Reduce min. load (under Application, menu item 3.6)
<i>INF 71</i>	Cannot store the current weight value (or entry) (e.g., control limits too low or too high)	None
<i>INF 72</i>	Cannot store the current weight value (e.g. transaction counter maximum reached)	None
<i>INF 73</i>	Data not found or unreadable	Contact your local Minebea Intec Service Center
<i>INF 74</i>	Function is blocked (e.g., menu is locked)	None
<i>INF 98</i>	No weighing platform connected	Contact your local Minebea Intec Service Center
<i>INF 99</i>	No weighing platform connected	Contact your local Minebea Intec Service Center
<i>NO WP</i>	No weighing platform connected	Contact your local Minebea Intec Service Center
Flashing 	Battery defective or time changed	Set the time

) = For SIWS models only

## Care and Maintenance

### Service

Regular servicing by a Minebea Intec technician will extend the service life of your equipment and ensure its continued weighing accuracy. Minebea Intec offers its customers service contracts with regular maintenance intervals ranging from 1 month to 2 years.

The frequency of the maintenance intervals depends on the operating conditions and user's tolerance requirements.

### Cleaning

- △ Unplug the scale from the power supply and unplug any data cables connected to the scale.
- Clean the scale with a cloth lightly moistened with soap solution.
- Wipe down the scale with a soft, dry cloth after cleaning.
- △ Make sure that no liquid enters the scale.
- △ Do not use aggressive cleaning agents (solvents or similar).

### Cleaning the stainless steel surfaces

All stainless steel parts should be cleaned at regular intervals. Remove the stainless steel load plate and thoroughly clean it separately. Use a damp cloth or sponge to clean stainless steel parts on the scale. You can use any commercially available household cleaning agent that is suitable for use on stainless steel. Stainless steel should be cleaned simply by rubbing. Then clean the load plate thoroughly, making sure to remove all residues. Use a damp cloth or sponge to clean stainless steel parts on the scale. After this, let the device dry. For additional protection, protective oil may be applied.

- △ Only use solvents for cleaning stainless steel parts.

### Corrosive Environment

- Remove all traces of corrosive substances from the scale on a regular basis.

### Replacing the dust cover

- > Replace damaged dust cover.
- Place the new dust cover on the display and control unit and press it over the edge of the front and rear side of the device until it is fixed in place.

### Safety Inspection

Safe operation of the equipment is no longer ensured:

- If the device or the mains connecting lead shows visible damage.
- If the integrated power supply for the display and control unit no longer functions properly.
- If the device has been stored for long periods under unfavorable conditions (e.g. extreme dampness).
- Following rough handling during shipment.  
If safe operation of the equipment can no longer be guaranteed:
- Disconnect the power supply to the equipment (unplug the power cord from the wall outlet).
- > Secure the equipment against further use.
- Notify your nearest Minebea Intec Service Center.

Maintenance measures may only be carried out by authorized Minebea Intec service technicians:

- Who have access to the required maintenance documents and manuals
- Who have attended appropriate service training courses
- △ The seals on the device indicate that the device may only be opened and maintained by authorized specialist personnel, so that the correct and safe operation of the device is ensured and the guarantee remains valid. If the verification seals are damaged, the equipment must be re-verified.

## Disposal

If the packaging is no longer needed, it can be disposed of by local waste disposal authorities. The packaging is made from environmentally-friendly materials that can be used as secondary raw materials.



The equipment, including accessories and batteries, should not be disposed of as regular household waste. EU legislation requires its Member States to collect electrical

and electronic equipment and dispose of it separately from other unsorted municipal waste with the aim of recycling it.

In Germany and several other countries, Minebea Intec itself assumes responsibility for the return and conformant disposal of its electronic and electrical products. Such equipment may not be thrown out with household waste or brought to collection centers run by local public disposal operations – not even by small commercial operators.

For disposal in Germany and in the other member nations of the European Economic Area (EEA), please contact our local service technicians or our Service Center in Bovenden Germany: Minebea Intec Bovenden GmbH & Co. KG  
Leinetal 2  
37120 Bovenden, Allemagne

WEEE registration number:  
WEEE Reg. No. DE 58091735

In countries that are not members of the European Economic Area (EEA) or where no Minebea Intec subsidiaries or dealerships are located, please contact your local authorities or a commercial disposal operator.

Prior to disposal and/or scrapping of the equipment, any batteries should be removed and disposed of in local collection boxes.

Minebea Intec will not take back equipment contaminated with hazardous materials (ABC contamination) – either for repair or disposal. Please refer to our website ([www.minebea-intec.com](http://www.minebea-intec.com)) or contact the Minebea Intec Service Department for more detailed information regarding repair service addresses or the disposal of your device.



## General Specifications

Digital protective interface	According to EN45501
Data Interface	Bidirectional RS-232C interface with control output (standard equipment)
Additional data interface	Optional
Display	14-segment backlit display
Weighing platform Housing: Display unit	SIWAEDG galvanized, all other types aluminum die-casting, Stainless steel
Dust and water protection acc. to EN60529	IP43 (optional IP65, standard for the SIWSDCS/SIWSBBS/SIWAEDG models)
Temperature range	-10°C to +40°C +10°C to +30°C (SIWS...-.CE)
Power supply: DC power supply AC power supply Battery operation	100–240 VAC (15/+10 %), 50–60 Hz, max. 17 W/23 VA optional 15.524 VDC (±10%), max. 12 W * optional 13–17 VAC (±10%), 50–60 Hz, max. 12 W * Via internal battery (only available as an option directly with order)*
Transient emissions	Acc. to EN61326+A1 Class B (IEC 61326+A1)
Interference resistance	Acc. to EN61326+A1, industrial environment (IEC61326+A1)
Electrical safety	Acc. to EN61010-1 (IEC 1010-1), EN60950 (IEC 950)

\* Not SIWAEDG

## Signum® Model Designator

Model Type	Sensor Technology	Platform Dimensions	Material/ Design	Application Level	Weighing Capacity (kg)	Display Resolution	Verifiable/ Verified Versions
SIWR example: SIWRDCP-1-3-1							
SIW	R <sup>1)</sup>	DC	P <sup>4)</sup>	1	3	I	
				2	6		RCE
				3	15		
					35		
					60		
SIWA example: SIWADCP-2-35-S							
SIW	A <sup>2)</sup>	DC	P <sup>4)</sup>	1	1	H	–
		BB	G <sup>6)</sup>	2	7	S	–
		ED		3	8	I	–
					16		–
					35		–
					65		–
SIWS example: SIWSDCP-3-16-H							
SIW	S <sup>3)</sup>	DC	P <sup>4)</sup>	1	06	S	SCE
		BB	S <sup>5)</sup>	2	3	H	HCE
				3	6		ICE
					16		
					35		

1) = SIWR: "Regular," standard weighing (strain gauges)

2) = SIWA: "Advanced," mechatronic weighing system (strain gauges)

3) = SIWS: "Supreme,": monolithic weighing system

4) = painted

5) = stainless steel

6) = galvanized

## Model-specific Data

### Weighing Data Signum® Regular SIWRDCP-1,-2,-3

#### Non-verifiable models

Weighing capacity (kg)	3	6	6
Readability (g)	0.1	1	0.2
Resolution code	-1	-R	-1
<b>Calibration weight value (in grams)</b>	2000	5000	5000
<b>Accuracy class</b>	M1	M2	M1

#### Verifiable/verified models

Type of construction	DG SI 300		
EC type approval no.	D07-09-010		
Weighing capacity (kg)	6		
Readability (g)	1		
Verification scale interval e (g)	1		
Verification scale interval e (g)	1		
Resolution code	-RCE		
<b>Calibration weight value (in grams)</b>	6000		

**Accuracy class** M2

#### For all models

Preload (kg)	1.2	1.2
Repeatability (g)	0.2	0.2
Linearity (g)	0.3	0.4
Ambient temperature (for use in legal metrology only)	-10°C....+40°C	

### Weighing Data Signum® Regular SIWRDCP-1,-2,-3

#### Non-verifiable models

Weighing capacity (kg)	15	15
Readability (g)	2	0.5
Resolution code	-R	-1
<b>Calibration weight value (in grams)</b>	5000	5000
<b>Accuracy class</b>	M2	M1

#### Verifiable/verified models

Type of construction	DG SI 300	
EC type approval no.	D07-09-010	
Weighing capacity (kg)	15	
Readability (g)	2	
Verification scale interval e (g)	2	
Resolution code	-RCE	
<b>Calibration weight value (in grams)</b>	15000	
<b>Accuracy class</b>	M2	

#### For all models

Preload (kg)	3	3
Repeatability (g)	4	4
Linearity (g)	2	1
Ambient temperature (for use in legal metrology only)	-10°C....+40°C	

## Model-specific Data

### Weighing Data Signum® Regular SIWRDCP-1,-2,-3

#### Non-verifiable models

Weighing capacity (kg)	35	35	60	60
Readability (g)	5/5	1	10	2
Resolution code	-R	-I	-R	-I
<b>Calibration weight (in grams)</b>	10000	10000	60000	60000
<b>Accuracy class</b>	M2	M1	M1	M1

#### Verifiable/verified models

Type of construction	DG SI 300			
EC type approval no.	D07-09-010			
Weighing capacity (kg)	35	60		
Readability (g)	5	10		
Verification scale interval e (g)	25	10		
Resolution code	-RCE	-RCE		
<b>Calibration weight (in grams)</b>	35000	60000		
<b>Accuracy class</b>	M2	M2		

#### For all models

Preload (kg)	6
Repeatability (g)	1
Linearity (g)	1.5
Ambient temperature (for use in legal metrology only)	-10°C....+40°C

### Resolutions for Signum® Regular

Non-verifiable		Verifiable	
- I	Resolution >30,000d		
- R	Resolution >6000d	-RCE	Single range Class III 1*6000/7500e

### Weighing Data for Signum® Advanced SIWABBP-1,-2,-3

#### Non-verifiable models

Weighing capacity (kg)	1.5	8
Readability (g)	0.01	0.1
Resolution code	-H	-I
Repeatability (g)	0.03	0.2
Linearity (g)	0.03	0.3
<b>Calibration weight value (in grams)</b>	1000	5000
<b>Accuracy class</b>	F1	F2

### Weighing Data for Signum® Advanced SIWADCP-1,-2,-3

#### Non-verifiable models

Weighing capacity (kg)	7	16	35	65
Readability (g)	0.1	0.2	0.5	1
Resolution code	-S	-S	-S	-S
Preload (kg)	-	-	-	-
Repeatability (g)	0.2	0.4	1	2
Linearity (g)	0.3			
<b>Calibration weight (in grams)</b>	5000	5000	10000	20000
<b>Accuracy class</b>	F2	F2	F2	F2

### Resolutions for Signum® Advanced

-S	Resolution >= 60,000 d
----	------------------------

## Model-specific Data

### Weighing Data for Signum® Regular SIWAEDG-3

Weighing Data Signum®	SIWAEDG-3-16-S	SIWAEDG-3-35-S	SIWAEDG-3-65-S
Weighing capacity (kg)	16	35	65
Readability (g)	0.2	0.5	1
Linearity (g)	0.6	1.5	3
Repeatability (g)	0.4	1	2
Weight bearing capacity (kg)	30	70	130
Ambient temperature range 0 - +40 °C Operating temperature range +10 - +30 °C			

### Weighing Data for Signum® Supreme SIWSBBP-1,-2,-3 / Non-verifiable models, \* SIWSBBS-3-H/6-H

Weighing capacity (kg)	0.620	3.1*	6.1*
Readability (g)	0.001	0.01	0.01
Resolution code	-H	-H	-H
Calibration weight value (in grams)	500	2000	5000
Accuracy class	E2	E1	E2

#### Verifiable/verified models

Type of construction	BD SI 200				
EC type approval no.	D07-09-010				
Weighing capacity (kg)	0,620 <sup>4)</sup>	3,1*	3,1	6,1 <sup>5)</sup>	6,1*
Readability (g)	0,001	0,01	0,1	0,1	0,01
Verification scale interval e (g)	0,01	0,1	0,1	0,1	0,1
Resolution code	-HCE	-HCE	-ICE	-SCE	-HCE
Calibration weight value (in grams)	500	2000	2000	5000	5000
Accuracy class	E2	E1	E2	E2	F1

#### For all models

Preload (kg)	0	3	3	0	0
Repeatability (g)	0.001	0.01	0.01	0.1	0.01
Linearity (g)	0.002	0.02	0.02	0.2	0.02
Ambient temperature (for use in legal metrology only)	+10°C.....+30°C				

#### Resolutions for Signum® Supreme

Non-verifiable (type)	Verified at factory (type)
-H Resolution > 100,000 d	-HCE Single range, Cl. II > 10,000 e, e = 10 d
-S Resolution > 60,000 d	-SCE Single range, Cl. II < 10,000 e, e = 10 d
-I Resolution > 30,000 d	-ICE Single range, Cl. II 30,000 e, e = d

Shortest settling time at menu setting	1-1-1	1,0 sec.
	1-1-2	1,3 sec.
	1-1-3	1,6 sec.
	1-1-4	2,8 sec.

<sup>4)</sup> = painted, <sup>5)</sup> = stainless steel

## Model-specific Data

### Weighing Data Signum® Supreme SIWSDCP/S-1,-2,-3

#### Non-verifiable models

Weighing capacity (kg)	6	16	35
Readability (g)	0.1	0.1	0.1
Resolution code	-S	-H	-H
Adjustment value (in grams)	5000	10,000	10,000
Accuracy class	F2	F1	F

#### Verifiable/verified models

Type of construction	BG SI 200		
EC type approval no.	D07-09-010		
Weighing capacity (kg)	6	16	35
Readability (g)	0.1	0.1	0.1
Verification scale interval e (g)	1	1	1
Resolution code	-SCE	-HCE	-HCE
Adjustment value (in grams)	5000	10,000	10,000
Accuracy class	F2	F1	F1

#### For all models

Preload (kg)	5
Repeatability (g) (verified models in compliance with EN45501)	0.2
Linearity (g) (verified models in compliance with EN45501)	0.2
Ambient temperature (for use in legal metrology only)	+10°C...+30°C

#### Resolutions for Signum® Supreme

Non-verifiable (type)	Verified at factory (type)
-S Resolution > 60,000 d	-SCE Single range, Cl. II < 10,000 e, e = 10 d
-H Resolution > 100,000 d	-HCE Single range, Cl. II > 10,000 e, e = 10 d

## Dimensions (Scale Drawings) Signum SIWAEDG

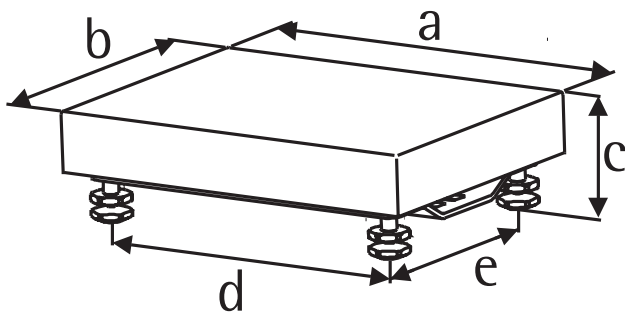

- a = 400
- b = 300
- c = 94...108
- d = 344
- e = 244

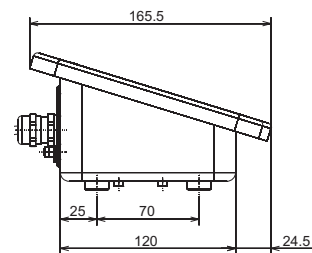

The dimensions of the indicator is identical with that of the indicator with the integrated battery. The indicator can be attached to the YDH12CWS screw-fixed sheet metal plate or to the YDH02CWP column (accessories).

**Operating Limits maximum Overload Capacity:** Minebea Intec weighing platforms are constructed to withstand rough treatment in industrial environments, the platform will not be damaged if occasionally loaded beyond the maximum weighing capacity. The maximum overload capacity of this is 300kg SIW\*DCP/S, 50kg SIW\*BBP/S.

### Dimensions (Scale Drawings)

SIWRDCP | SIWADCP | SIWSDCP:

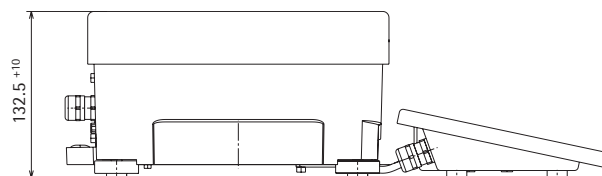
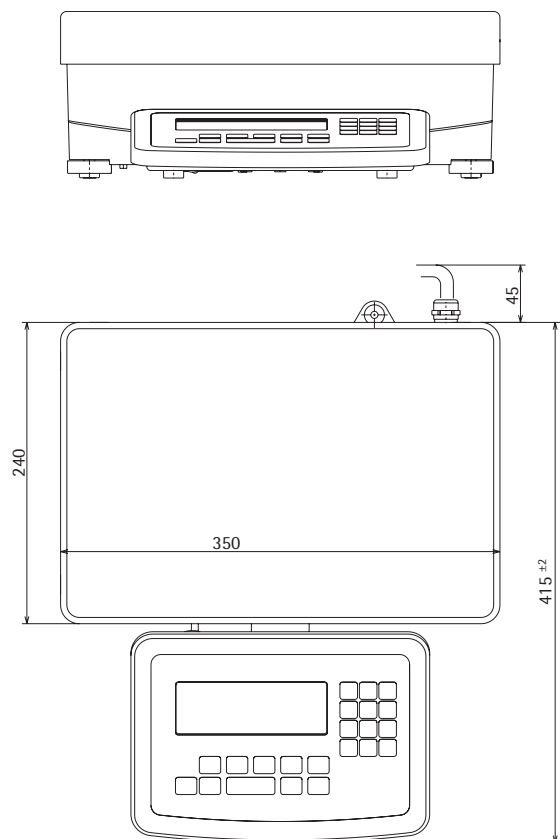

Standard version:

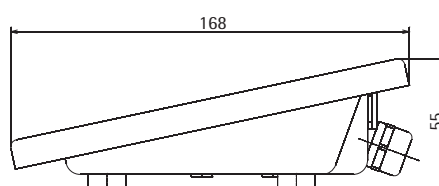

With integrated rechargeable battery:

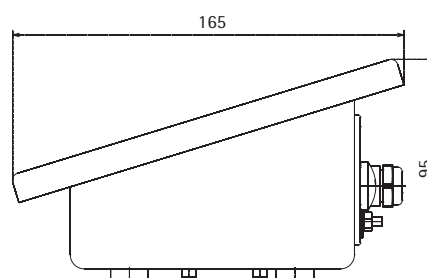

SIWSDCS:

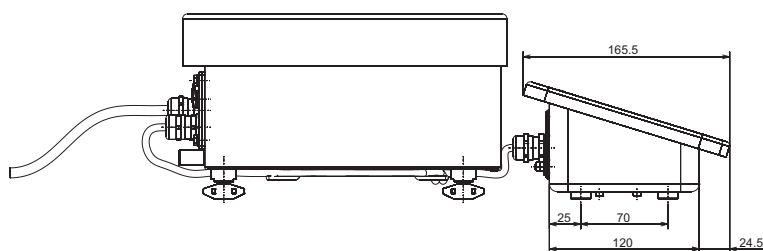
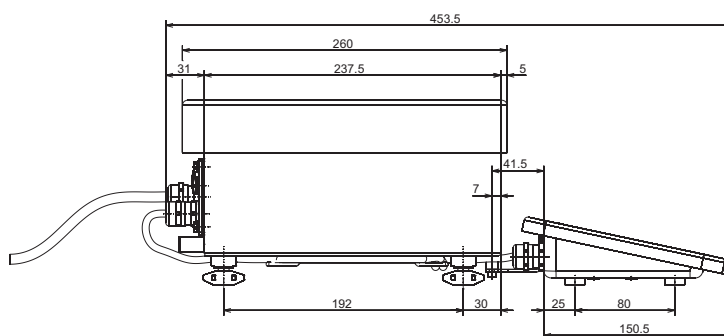
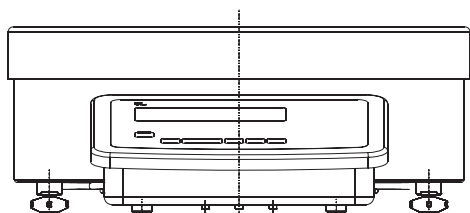
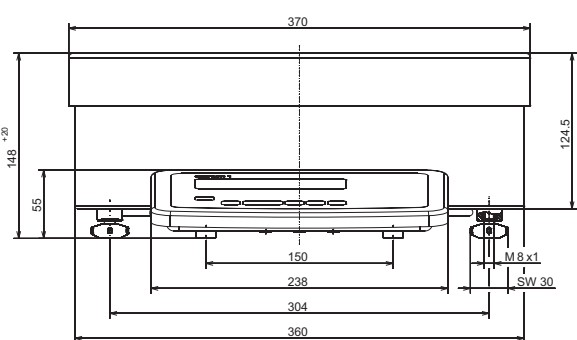

All dimensions are given in millimeters

Dimensions (Scale Drawings)

SIWABBP, SIWSBBP:

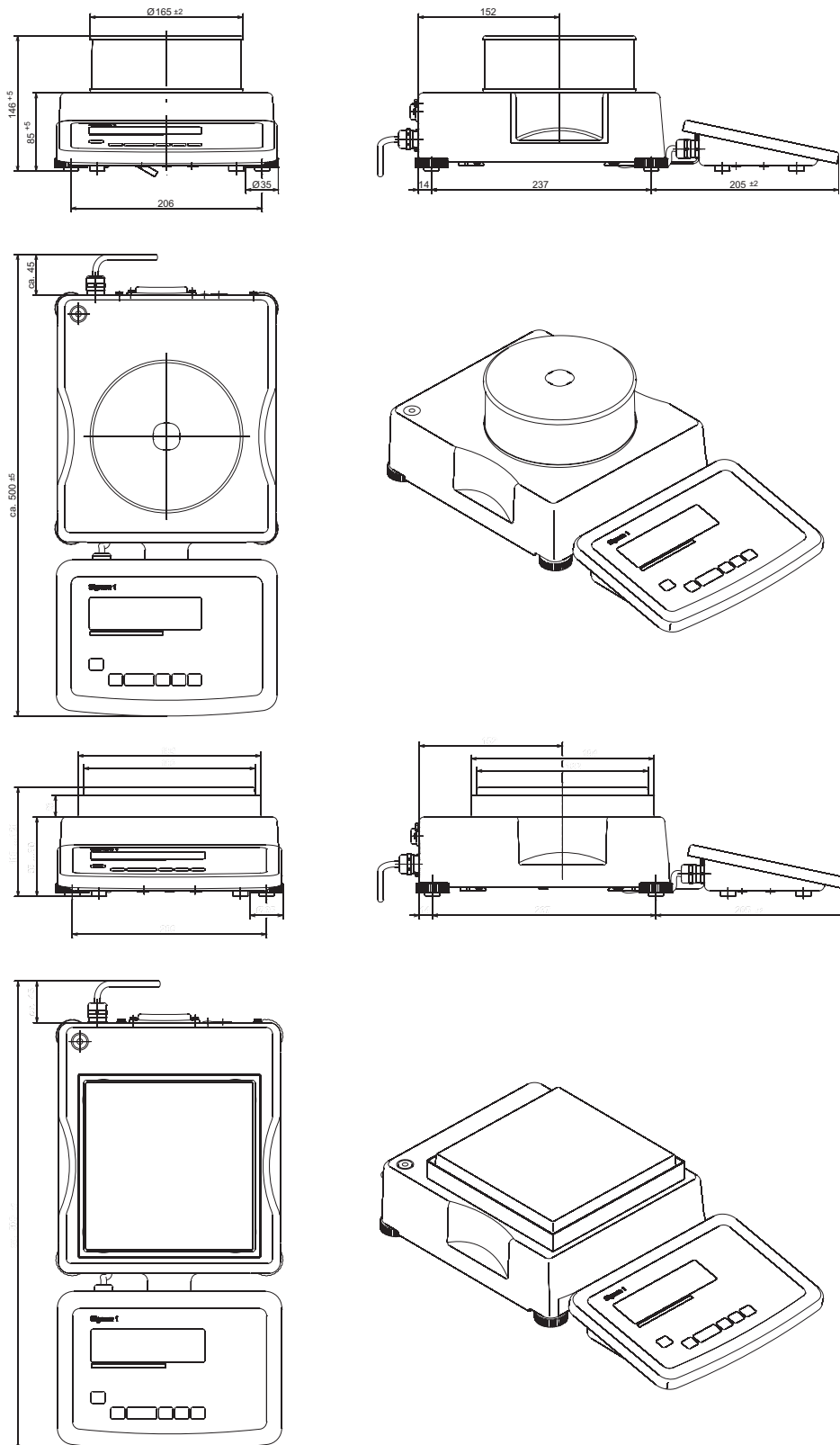

All dimensions are given in millimeters

## Dimensions (Scale Drawings)

SIWSBBS:

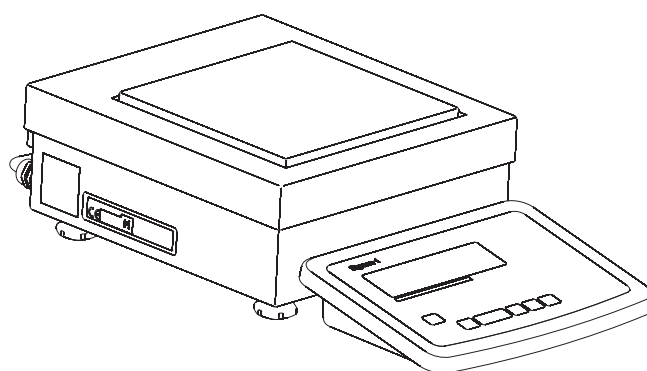
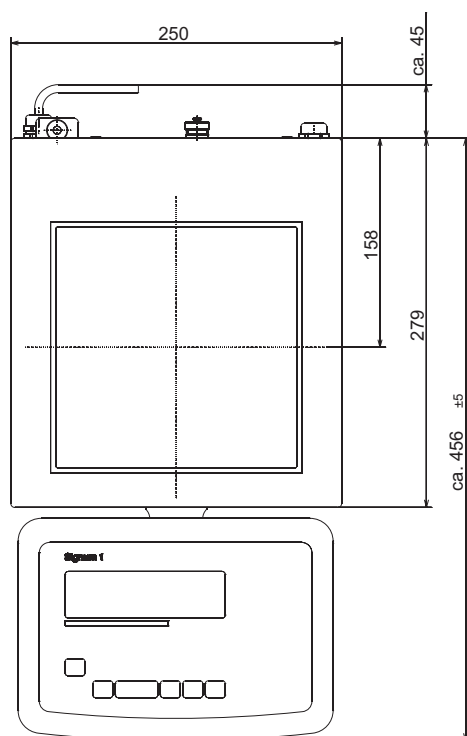
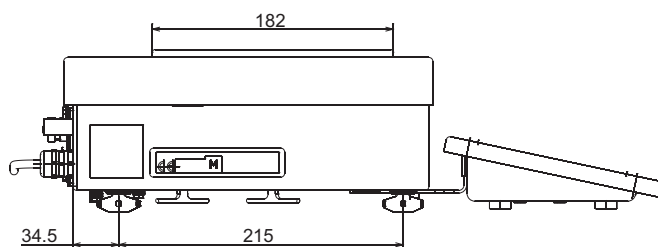
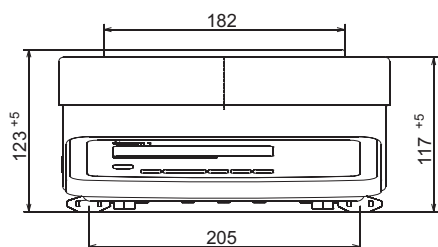

All dimensions are given in millimeters



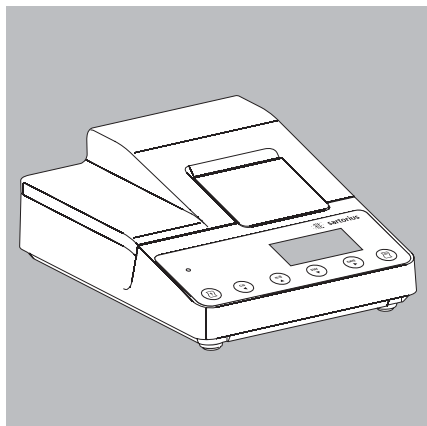

YDP20-OCE

## Accessories

### Indicator accessories:

### Printer and printer accessories

Verifiable data printer with date, time and statistics program	YDP20-OCE
5x50 m paper rolls for data printer	6906937
Replacement ink ribbon cartridge for printer	6906918



YDP05

Verifiable strip and label printer with thermal print head, paper width 60 mm, with adapter cable (12-pin round male connector) and external power supply.	YDP05
--	-------

Adapter cable	YCC01-01CISLM3
Verifiable strip/label printer with thermal printing unit, paper width up to 108 mm, with external mains unit 100-240 Volt and mains lead (EU +US); only for use with flexible print design, connection cable required	YDP4IS-OCEUV
	YCC01-01CISLM3

Labels for YPD04IS-OCEUV + YDP14IS-OCEUV	
labels 58x30 mm (1000 labels)	69Y03092
labels 58x76 mm (500 labels)	69Y03093
labels 58x100 mm (380 labels)	69Y03094

Labels for YDP14IS-OCEUV	
labels 101x127 mm (305 labels)	69Y03195

Printer paper for YDP04IS-OCEUV + YDP14IS-OCEUV	
3 paper rolls, 60 mmx75 m, thermal paper	69Y03090

Printer paper for YDP14IS-OCEUV	
1 paper roll, 101 mmx75 m, thermal paper	69Y03196



YDP14IS

Verifiable strip/label printer with thermal printing unit, paper width up to 108 mm, with external mains unit 100-240 Volt and mains lead (EU +US); only for use with flexible print design, connection cable required.	YDP14IS-OCEUVTH
---	-----------------

Item	Order no.
<b>Interfaces*</b>	
UNICOM: RS-232 interface module	YD001SW-232
UNICOM: RS-485/422 interface module	YD001SW-485/422
UNICOM: Analog current output interface module 0–20 mA, 4–20 mA, 0–10 V, 16 bit	YD001SW-AO
UNICOM: Ethernet interface module	YD001SW-ETH
UNICOM: Dig. I/O interface module	YD001SW-DIO
UNICOM: Profibus DP interface module	YD001SW-DP
Connection cable from RS-232 data interface to USB port on PC	YCC01-USBM2
Adapter plate for future UNICOM installation **	YAS01SW-CON

\* Not available for SIWSDCS/SIWSBBS models

\*\* Not for SIWAEDG

<b>Electrical Accessories **</b>	
External red/green/red display	YRD14Z
2nd display	YRD02Z
Barcode scanner, 120 mm scanning width, with connection cable for Signum® 2 and 3	YRB02-PS2
Foot switch, incl. D-Sub 25-pin T-connector	YFS01
Hand switch, incl. D-Sub 25-pin T-connector	YHS02
Cable for YD0015W-A0 current interface, with open cable ends e.g., 5 x 5 m	6906926
Flexible formatting options for printouts (e.g., for barcode, variable font size, graphics, etc.)	Upon request

\*\* For model SIWSDCS/SIWSBBS/SIWAEDG can only be used in combination with a corresponding adapter plate. Please contact your Minebea Intec dealer.

<b>Software</b>	
Flexible formatting options for printouts (e.g., for barcode, variable font size, graphics, etc.).	YAD02IS
Minebea Intec WinScale driver software for Windows 95/98/2000/NT. Displays the scale readout on your PC monitor and provides secure memory for storing data that is subject to legal control. RS-232 connection cable YCC01-09ISM5 required (RS-485 connection cable upon request).	YSW03
SartoConnect data transfer software (for loading weight values to a PC running Windows® 95/98/NT and direct processing with application programs such as Excel, Access, etc.) incl. connection cable (1.5 m) from scale to PC (12-pin to 9-pin)	YSC01L
<b>Mechanical Accessories</b>	
Display support column for Signum SIW*DCP* models, column height 500 mm	YDH01P
Display support column for Signum SIW*BBP* models, column height 400 mm	YDH02P
Display support column for Signum SIW*EDG* models, column height 500 mm	YDH02CWP
Display support column for Signum SIW*DCS* models, column height 330 mm	YDH01CWS
Stainless steel display support column for Signum SIW*DCS* models, column height 500 mm	YDH02CWS
Stainless steel display support column for Signum SIW*DCS* models, column height 750 mm	YDH03CWS
Brackets for wall mounting, stainless steel	YDH01CIS
Brackets for wall mounting, stainless steel, tiltable	YDH02CIS
Guard covers (x2)	YDC01SW

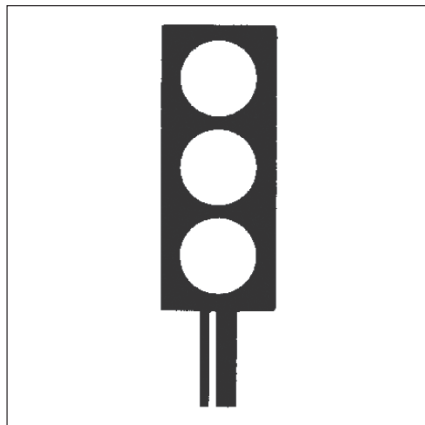
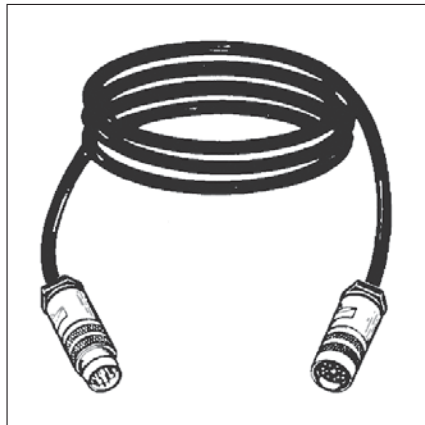

**Items for SIWSDCS/SIWSBBS Models**

**Order no.**

**Cables and Plugs**

Data cable for direct connection for printer YDP03-OCE	YCC01-0019M3
Data cable for PC connection, 25-pin (5 m)	YCC01-03ISM5
Data cable for PC connection, 9-pin (5 m)	YCC01-09ISM5
Round plug for individual cable assembly	69QC0010
Data adapter cable (round plug) for RS-232-DB25 socket for connecting standard Minebea Intec accessories	YCC01-0016M3
Data cable extension (round plug/round socket) (6 m)	YCC01-01ISM6
Connection cable YDP04/12IS-OCEUV and YDP12IS-OCEUVTH to FC scales, 9-pin D-SUB plug to 12-pin round plug	69Y03142
Data connection cable (5 m) with open cable ends	YCC01-03M5

**Electrical Accessories**

Barcode scanner (can only be connected to the corresponding double data interfaces on PC models)	YRB02FC
T-connector for simultaneous connection of devices with a serial interface and control devices with a 12-pin round plug	YTC02-CC1M1
T-connector for simultaneous connection of printer and barcode reader with a 12-pin round plug	YTC02-PB1M1
External control display with mounting bracket for column installation (red/green/red light) with 12-pin round plug	YRD14Z

**Items for SIWAEDG Models**

**Order no.**

**Accessories**

Data output RS-232	YD001SW-232
Data output RS-485/422)	YD001SW-485/422
4-20mA	YD001SW-AO
Digital I/O	YD001SW-DIO
Profibus DP	YD001SW-DP
Ethernet	YD001SW-ETH
Connection cable accessory 25-pin DSUB	YCC02-D25F6
Connection cable YDP20* and PC	YCC02-D09F6
Connection cable YDP12/04IS	YCC02-D09M6

\*) The cable gland must be set back for this option

The attachment of the connection cables is carried out by the customer using the regular Combics connection cable.

The cover cannot turn when using UNICOM interfaces.

## **"Installation"**

### **a service offered by Minebea Intec**

#### **"Installation" service in Germany**

Our "Installation" service package provides the following services:

- Setup
- Getting Started
- Inspection
- Instruction

If the installation of the weighing instrument is to be carried out by Minebea Intec, please request this service from a customer service employee.

#### **Re-verification in Germany**

Scale verification for legal metrology is valid until the end of the calendar year after next. If the scale is used for fill level control in accordance with legislation on prepackaging, verification is valid until the end of the following calendar year. Re-verification must currently be carried out by a weights and measures official. Re-verification should be requested in good time from the local Weights and Measures office. As appropriate, please observe all statutory amendments.

#### **Subsequent Verifications within European Countries**

The expiration date of the verification depends on the national regulations of the country in which the weighing instrument is used. For information on verification and legal regulations currently applicable in your country, and to obtain the names of the persons to contact, please contact your local Minebea Intec office, dealer, or Service Center.

Further information concerning "verification" can be obtained from our customer service centers.



## EU- / EG-Konformitätserklärung EU / EC Declaration of Conformity

Hersteller  
*Manufacturer*

Minebea Intec Bovenden GmbH & Co. KG  
Leinetal 2, 37120 Bovenden, Germany

erklärt in alleiniger Verantwortung, dass das Betriebsmittel  
*declares under sole responsibility that the equipment*

Geräteart  
*Device type*

Signum Komplettwaage  
Signum Complete Scale

Baureihe  
*Type series*

SIWRDCP-...-..., SIWSBBP-...-..., SIWSBBS-...-..., SIWSDCP-...-..., SIWSDCS-...-...

in der von uns in Verkehr gebrachten Ausführung allen einschlägigen Bestimmungen der folgenden Europäischen Richtlinien - einschließlich deren zum Zeitpunkt der Erklärung geltenden Änderungen - entspricht und die anwendbaren Anforderungen folgender harmonisierter Europäischer Normen erfüllt:  
*in the form as delivered fulfils all the relevant provisions of the following European Directives - including any amendments valid at the time this declaration was signed - and meets the applicable requirements of the harmonized European Standards listed below:*

2014/30/EU

Elektromagnetische Verträglichkeit  
*Electromagnetic compatibility*  
EN 61326-1:2013

2006/42/EG  
2006/42/EC

Nur für Geräte mit interner Justiergewichtsschaltung | Only for devices with internal calibration weight  
Maschinen  
*Machines*  
EN ISO 12100:2010, EN 61010-1:2010

Für alle anderen Geräte ohne interner Justiergewichtsschaltung | For all other devices without internal calibration weight

2014/35/EU

Elektrische Betriebsmittel zur Verwendung innerhalb bestimmter Spannungsgrenzen  
*Electrical equipment designed for use within certain voltage limits*  
EN 61010-1:2010

2011/65/EU

Beschränkung der Verwendung bestimmter gefährlicher Stoffe in Elektro- und Elektronikgeräten (RoHS)  
*Restriction of the use of certain hazardous substances in electrical and electronic equipment (RoHS)*  
EN 50581:2012

2014/34/EU

Nur für Geräte mit Option Y2 | Only for devices with option Y2  
Geräte und Schutzsysteme zur bestimmungsgemäßen Verwendung in explosionsgefährdeten Bereichen  
*Equipment and protective systems intended for use in potentially explosive atmospheres*  
EN 60079-0:2012, EN 60079-11: 2012, EN 60079-15:2010, EN 60079-31:2014

Kennzeichnung II 3G Ex nA ic IIC T4 Gc  
*Marking* II 3D Ex tc IIIC T80°C Dc

Referenz Herstellerbescheinigung Nummer: SIS14ATEX007X  
*Reference Manufacturer's Certificate number:*



## EU- / EG-Konformitätserklärung EU / EC Declaration of Conformity

Jahreszahl der CE-Kennzeichenvergabe / *Year of the CE mark assignment: 17*

Die Person, die bevollmächtigt ist, die technischen Unterlagen zusammenzustellen:  
*The person authorised to compile the technical file:*

Minebea Intec Bovenden GmbH & Co. KG, Research & Development, Leinetal 2, 37120 Bovenden,  
Germany

Minebea Intec Bovenden GmbH & Co. KG  
Bovenden, 2017-02-08

Dr. Bodo Krebs  
President

Dr. Jörg Hachenberg  
Head of Mechatronics

Diese Erklärung bescheinigt die Übereinstimmung mit den genannten EU/EG Richtlinien, ist jedoch keine  
Zusicherung von Eigenschaften. Bei einer mit uns nicht abgestimmten Änderung des Produktes verliert diese  
Erklärung ihre Gültigkeit. Die (Sicherheits-)Hinweise der zugehörigen Produktdokumentation sind zu beachten.

*This declaration certifies conformity with the above mentioned EU/EC Directives, but does not guarantee product  
attributes. Unauthorised product modifications make this declaration invalid. The (safety) information in the  
associated product documentation must be observed.*



Physikalisch-Technische Bundesanstalt  
Nationales Metrologieinstitut

KBS

Konformitätsbewertungsstelle

PTB • Postfach 33 45 • 38023 Braunschweig

Minebea Intec Bovenden GmbH & Co. KG

Leinetal 2  
D-37120 Bovenden

Ihr Zeichen: Metrology Department  
Ihre Nachricht vom:  
Mein Zeichen: PTB-1.1  
Meine Nachricht vom:

Bearbeitet von: Dr.-Ing. D. Knopf  
Telefordurchwahl: 0531 592 1100  
Telefaxdurchwahl:  
E-Mail: dorothea.knopf@ptb.de

Datum: 02.02.2017

#### Sammelschreiben zur Zertifikatsübertragung

Sehr geehrter Herr,

hiermit teilen wir Ihnen mit, dass die von der KBS der PTB gegenüber der Firma *Sartorius Industrial Scales GmbH & Co. KG* ausgestellten, unten aufgelisteten Zertifikate zum 29.11.2016 für die Firma *Minebea Intec Bovenden GmbH & Co. KG* gelten. Die *Minebea Intec Bovenden GmbH & Co. KG* ist nach den uns vorliegenden Informationen bezüglich dieser Zertifikate in alle Rechte und Pflichten der *Sartorius Industrial Scales GmbH & Co. KG* eingetreten. Diese Änderung wird bei etwaigen Revisionen der Zertifikate berücksichtigt werden.

Dies betrifft folgende Zertifikate:

EG-Bauartzulassungen:

D97-09-018, D07-09-010, DE-08-MI006-PTB040, DE-08-MI006-PTB034,

Evaluation-Certificates nach WELMEC 8.8:

DE-15-EC-PTB002, DE-15-EC-PTB005,

Prüfscheine:

D09-11.02, D09-07.21, D09-06.13, D09-00.28, D09-00.18, D09-99.15, D09-96.30, D09-95.18,  
D09-03.13, D09-07.56, D09-03.29, D09-99.06, D09-97.07, D09-96.19, D09-95.30, D09-95.20,  
D09-95.09, D09-95.08

Für weitere Informationen stehen wir Ihnen gerne zur Verfügung.

Mit freundlichen Grüßen  
Im Auftrag

600 30 b

Hausadresse, Lieferanschrift:  
Bundesallee 100  
38116 Braunschweig  
DEUTSCHLAND

Telefon: +49 531 592-0  
Telefax: +49 531 592-9292  
E-Mail: poststelle@ptb.de  
Da-Mail: poststelle@ptb.de-mail.de  
Internet: <http://www.ptb.de>

Deutsche Bundesbank, Filiale Leipzig  
IBAN: DE38 8600 0300 0086 0010 40  
BIC: MARKDEF1860  
VAT-Nr.: DE 811 240 952

PTB Berlin-Charlottenburg  
Abtestr.: 2-12  
10537 Berlin  
DEUTSCHLAND







# Physikalisch-Technische Bundesanstalt

Braunschweig und Berlin



## EG-Bauartzulassung

EC Type-approval Certificate

Zulassungsinhaber: <i>Issued to:</i>	Sartorius Industrial Scales GmbH & Co. KG Leinetal 2 37120 Bovenden	
Rechtsbezug: <i>In accordance with:</i>	Richtlinie 2009/23/EG vom 23. April 2009 über nichtselbsttätige Waagen (ABl. L 122 S. 6). Directive 2009/23/EC of 23 April 2009 on non-automatic weighing instruments (OJ L 122 p. 6)	
Bauart: <i>In respect of:</i>	Nichtselbsttätige elektromechanische Waage mit oder ohne Hebelwerk <i>Non-automatic electromechanical weighing instrument with or without lever system</i>	
Typ: <i>Type:</i>	BD SI 200, BG SI 200, DG SI 300, DX SI 300 Max 0,1 kg ... 300 t Option: Mehrbereichs- und Mehrteilungswaage <i>multi-interval and multiple range instrument</i>	
	Ⓘ n ≤ 35000, Ⓜ n ≤ 7500, Ⓝ n ≤ 1000	
Zulassungsnummer: <i>Approval No.:</i>	<b>D07-09-010 5. Revision</b>	
Gültig bis: <i>Valid until:</i>	18.06.2019	
Anzahl der Seiten: <i>Number of pages:</i>	24	
Geschäftszeichen: <i>Reference No.:</i>	PTB-1.12-4064999	
Benannte Stelle: <i>Notified Body:</i>	0102	
Zertifizierung: <i>Certification:</i>	Braunschweig, 03.09.2013	Bewertung: <i>Evaluation:</i>
Im Auftrag <i>On behalf of PTB</i>	Siegel <i>Seal</i>	Im Auftrag <i>On behalf of PTB</i>
 Dr. Oliver Mack		 Timo Schwabe

EG-Bauartzulassungen ohne Unterschrift und Siegel haben keine Gültigkeit. Diese EG-Bauartzulassung darf nur unverändert weiterverbreitet werden. Auszüge bedürfen der Genehmigung der Physikalisch-Technischen Bundesanstalt.

EC Type-approval Certificates without signature and seal are not valid. This EC Type-approval Certificate may not be reproduced other than in full. Extracts may be taken only with the permission of the Physikalisch-Technische Bundesanstalt.

Die Hauptmerkmale, Zulassungsbedingungen und Auflagen sind in der Anlage enthalten, die Bestandteil der EG-Bauartzulassung ist. The principal characteristics, the approval conditions and the special conditions, if any, are set out in the Annex which forms an integral part of the EC Type-approval Certificate.



**Plates and Markings**

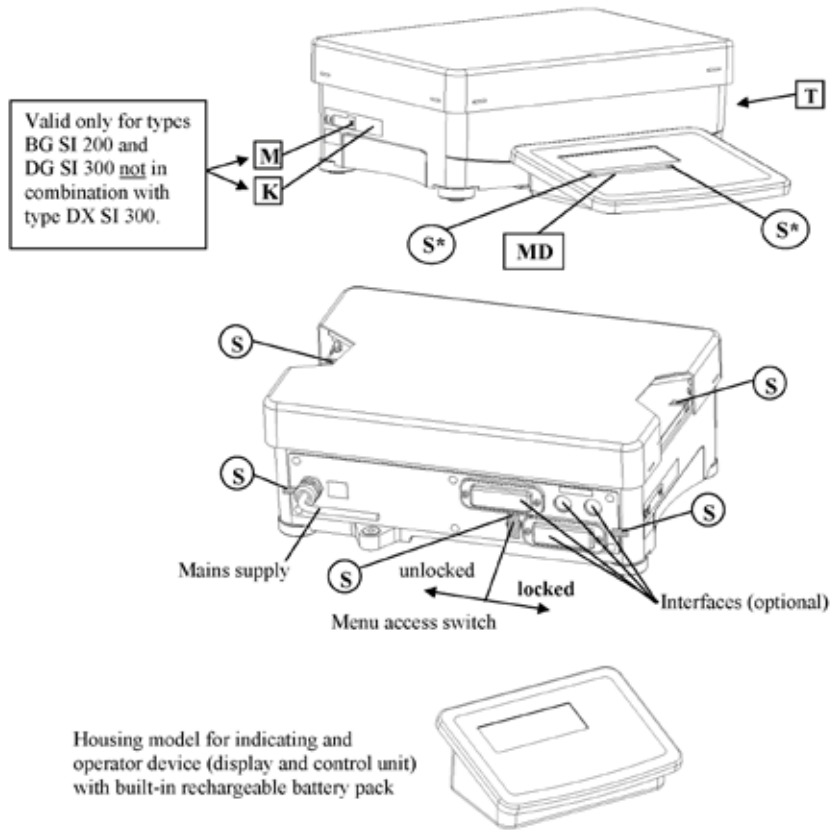

- K** Descriptive plate (ID label) with CE mark
- M** Green metrology sticker
- S** Protective mark (self-adhesive label or seal)
- S\*** Protective mark, for transferable labels only (detachable labels that remain intact after removal)
- MD** Metrological data: Max, Min, e and d
- T** Plate with model designation

PPSI01.0312e

Type of weighing instrument: BD SI 200, BG SI 200, DG SI 300, DX SI 300  
 EC type-approval certificate D07-09-010



Valid only for type  
BD SI 200 not in  
combination with  
type DX SI 300.

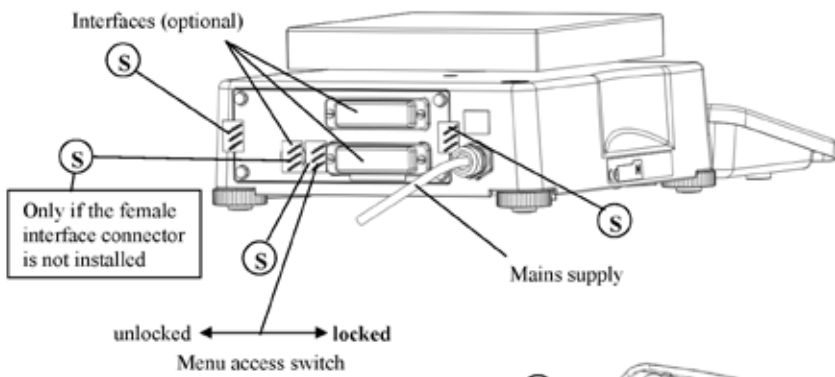
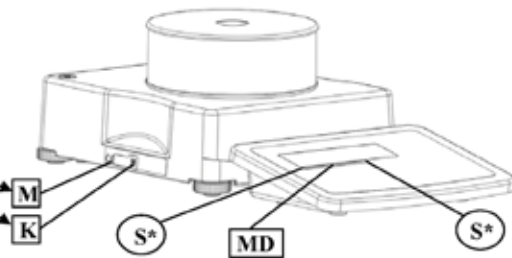

Housing model for indicating and  
operator device (display and  
control unit) with built-in  
rechargeable battery pack

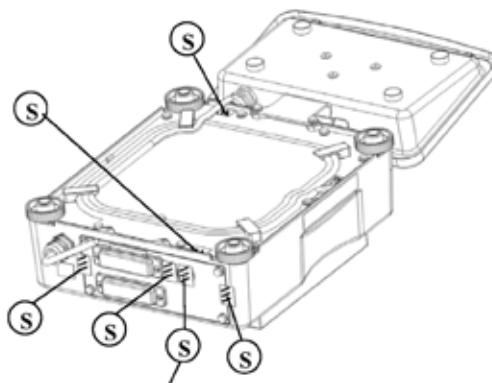

PPSI010312c

Type of weighing instrument: BD SI 200, BG SI 200, DG SI 300, DX SI 300  
EC type-approval certificate D07-09-010

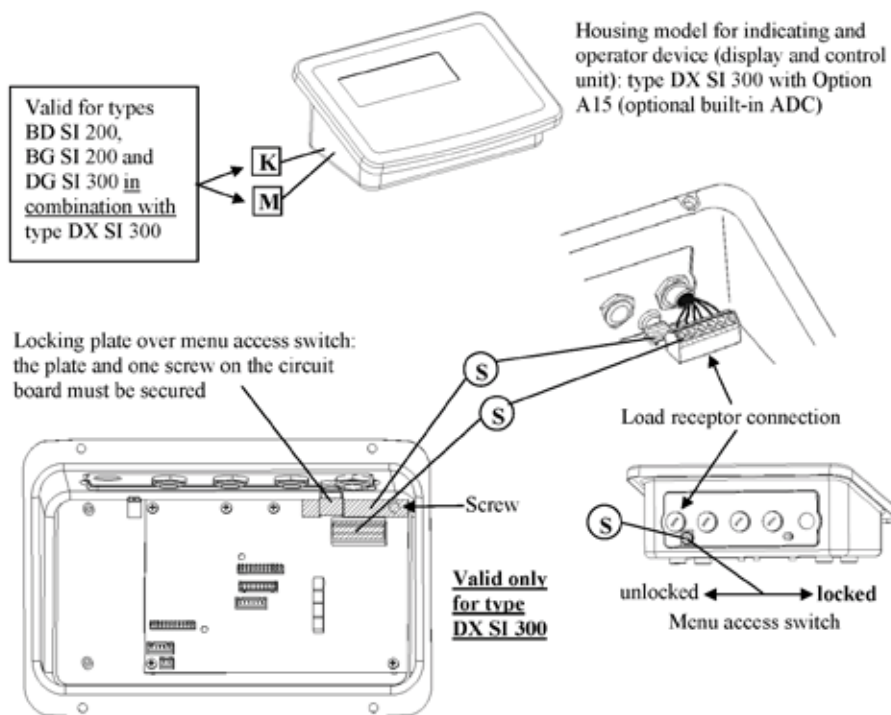

Alternative separable plug connection between indicator and load receptor for type DX SI 300

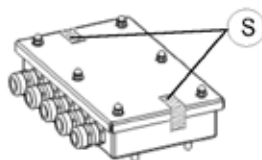

If there is a junction box between the load receptor and the electronic evaluation unit, it must be secured against tampering (type DX SI 300 only).

PPSI010312e

Type of weighing instrument: BD SI 200, BG SI 200, DG SI 300, DX SI 300  
EC type-approval certificate D07-09-010

## Stainless steel variants of Type BG SI 200

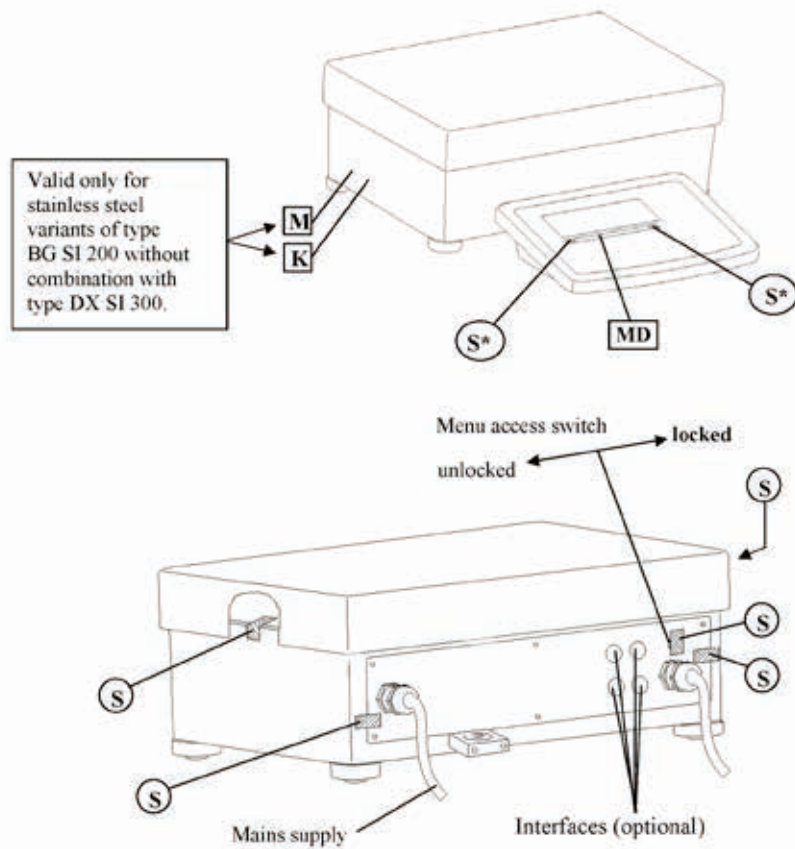

## Stainless steel variants of Type BD SI 200

PPSI010312e

Type of weighing instrument: BD SI 200, BG SI 200, DG SI 300, DX SI 300  
 EC type-approval certificate D07-09-010

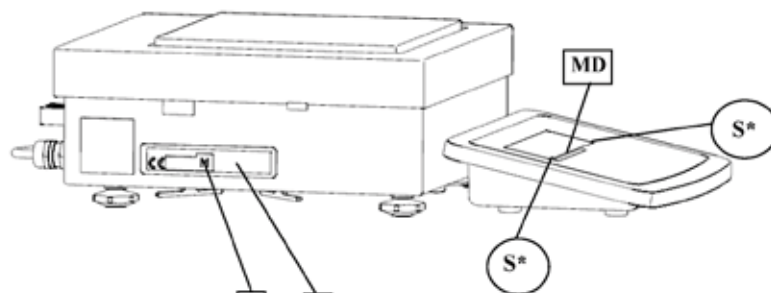

Valid only for types  
BD SI 200 without  
combination with  
type DX SI 300.



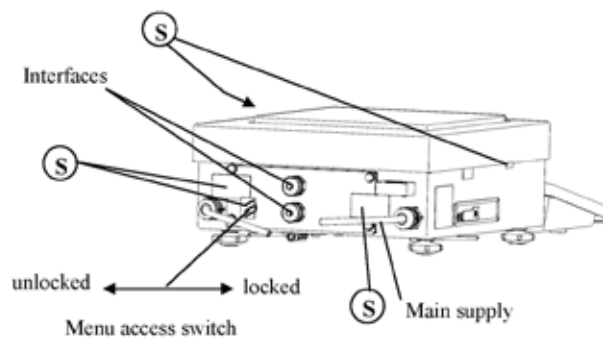



Variant of housing of the indicating and operator  
device for internal battery pack

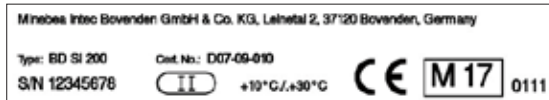

**For type BD SI 200, BG SI 200 or DG SI 300 without type DX SI 300**

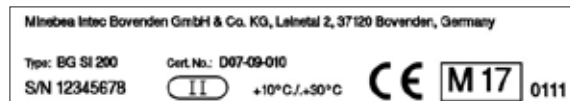
PPSI010312e

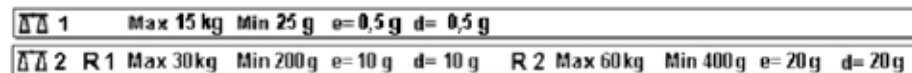
Type of weighing instrument: BD SI 200, BG SI 200, DG SI 300,  SI 300  
EC type-approval certificate D07-09-010

Example of descriptive plate on a weighing instrument that has been verifiedExample of plate with model designation Example of label with metrological data **For type BG SI 200 or DG SI 300**Example of descriptive plate on a weighing instrument that has been verified Example of plate with model designation Example of labels with metrological data 



## Herstellerbescheinigung Manufacturer's Certificate



**sartorius intec**  
A Minebea Group Company

Hersteller  
Manufacturer

Sartorius Industrial Scales GmbH & Co. KG  
Leinetal 2, D-37120 Bovenden, Germany

bescheinigt in alleiniger Verantwortung, dass das Betriebsmittel  
*certifies under own responsibility that the equipment*

Geräteart  
Device type

Signum Komplettwaage / *Signum complete scale*  
Signum Wägeplattform / *Signum weighing platform*

Baureihe  
Type series

SIWxBBy-...-..., SIWxDCy-...-..., ISBBY-...-..., ISDCy-...-... mit / with Option Y2  
x = A,R oder/for S; y = P oder/for S

auf das sich diese Bescheinigung bezieht, in der von uns in Verkehr gebrachten Ausführung mit der/den folgenden Norm(en) oder normativen Dokument(en) übereinstimmt (siehe Seite 2) gemäß den Bestimmungen der „Richtlinie 94/9/EG des Europäischen Parlaments und des Rates vom 23. März 1994 zur Angleichung der Rechtsvorschriften der Mitgliedstaaten für Geräte und Schutzsysteme zur bestimmungsgemäßen Verwendung in explosionsgefährdeten Bereichen“. Das Produkt wird wie folgt gekennzeichnet:

*to which this certification relates in the form as delivered complies with the following standard(s) or other normative document(s) (see page 2) pursuant to the provisions of the "Directive 94/9/EC of the European Parliament and the Council of 23 March 1994 on the approximation of the laws of the Member States concerning equipment and protective systems intended for use in potentially explosive atmospheres". This product is labelled as follows:*



II 3G Ex nA IIC T6 Gc  
II 3D Ex tc IIIC T80°C Dc  
SWT12ATEX006X

Sartorius Industrial Scales GmbH & Co. KG  
Bovenden, 2014-03-03

  
Dr. Bodo Krebs  
Senior Vice President

  
Dr. Dieter Klausgrete  
Head of International Certification Management

Diese Erklärung bescheinigt die Übereinstimmung mit der genannten EG-Richtlinie, ist jedoch keine Zusicherung von Eigenschaften. Bei einer mit uns nicht abgestimmten Änderung des Produktes verliert diese Erklärung ihre Gültigkeit. Die Sicherheitshinweise der zugehörigen Produktdokumentation sind zu beachten.

*This declaration certifies conformity with the above mentioned EC Directive, but does not guarantee product attributes. Unauthorised product modifications make this declaration invalid. The safety information in the associated product documentation must be observed.*



Die grundlegenden Sicherheits- und Gesundheitsanforderungen werden erfüllt durch  
Übereinstimmung mit:

*Compliance with the Essential Health and Safety Requirements has been assured by compliance with:*

EN 60079-0: 2012  
Explosionsfähige Atmosphäre – Teil 0: Geräte – Allgemeine Anforderungen  
*Explosive atmospheres – Part 0: Equipment – General requirements*

EN 60079-15:2010  
Explosionsfähige Atmosphäre – Teil 15: Geräteschutz durch Zündschutzart „n“  
*Explosive atmospheres – Part 15: Equipment protection by type of protection „n“*

EN 60079-31:2009  
Explosionsfähige Atmosphäre – Teil 31: Geräte – Staubexplosionsschutz durch Gehäuse „t“  
*Explosive atmospheres – Part 31: Equipment dust ignition protection by enclosure „t“*

\* \* \* \* \*

#### Technische Daten / *Specifications:*

Umgebungstemperatur / *Ambient temperature range:* -10°C ... +40°C

IP-Schutz / *IP protection:* IP6x

#### Versorgungsspannung / *Supply voltage*

Standard: 100-240 Vac, 50-60 Hz, 15VA (max), Um = 250V

Option LB: 24 Vdc, 12 W (max), Um = 30 V

\* \* \* \* \*

#### Besondere Bedingungen für den sicheren Gebrauch / *Special conditions for safe use:*

Sicherheitshinweise 36287-740-16, Rev. 01

*Safety instructions 36287-741-16, Rev. 01*

\* \* \* \* \*

#### Prüfbericht / *Test Report*

SWT.12.ATEX.001 (Sartorius Weighing Technology GmbH, Goettingen, Germany)

\* \* \* \* \*







## Keyword Index

	Page		Page
<b>Accessories</b>	102 ff.	<b>Key Functions</b>	8, 9
Adjustment	26, 43 ff.	<b>Legal Metrology: Use</b>	5
Animal Weighing	59	<b>Maintenance</b>	93
Applications Advice	2	<b>Net-total Formulation</b>	75
Automatic Data Output	87	<b>Neutral Measurement</b>	56
Average Piece Weight Updating	51	<b>Operating Concept</b>	9
Averaging	59	<b>Operating Menu Overview</b>	18
<b>Cabling Diagram</b>	86	<b>Operation</b>	39
Calibrate	26, 43 ff.	<b>Overview of Parameters</b>	19 ff.
CE Mark	105	<b>Password</b>	16
Checkweighing	65 ff.	<b>Password</b>	17
Classification	69	<b>Passwords</b>	Appendix
Cleaning	93	<b>Pin Assignment Chart</b>	85
Cleaning Stainless Steel Surfaces	93	<b>Plates and Markings</b>	110
COM1 Interface: Settings	27	<b>Printer Configuration</b>	27 ff.
Commands (Interface)	87	<b>Printing</b>	81 ff.
Configure Data Output	81	<b>Printouts: Settings</b>	35, 81
Connecting a Barcode Scanner	84	<b>Repairs</b>	93
Connecting the Device to AC Power	5	<b>Safety Inspection</b>	93
Connection Options	84, 85	<b>Safety Precautions</b>	4
Counting	53	<b>SBI Communication</b>	87
<b>Data Input Format</b>	87	<b>Scale Drawings</b>	99
Data Interfaces	84 ff.	<b>Setting the Language</b>	16, 38
Data Output Format	85	<b>Setting the Time</b>	17, 36
Data Protocols: Settings	27 ff.	<b>Settings</b>	16
Date Settings	17, 36	<b>Shutoff, Automatic</b>	13
Declaration of Conformity	104	<b>Specifications</b>	94 ff.
Device Parameters	25 ff.	<b>Totalizing</b>	72
Device-specific Information	38	<b>Universal Interface</b>	84, 85
Dimensions	99	<b>Unpacking the Equipment</b>	5
Displayed Elements	12	<b>Warm-up Time</b>	5
Disposal	93	<b>Warning Information</b>	4
<b>EC Conformity Mark</b>	105	<b>Weighing</b>	39
EC Type Approval Certificate	109	<b>Weighing in Percent</b>	62
Entering Geographical Data	5	<b>Weighing Platform WP1: Settings</b>	25 ff.
Equipment Supplied	5	<b>Weighing Platform, Leveling</b>	7
Error Messages	92		
External Keys	34		
<b>General Password</b>	Appendix (117)		
General View of the Equipment	8		
Getting Started	5		
GMP-compliant Printouts	91		
<b>Identifiers</b>	49		
Installation Instructions	5		
Intended Use	2		
IP Protection Rating	4, 93		

## Appendix: General Password



Press repeatedly **Fn**, **→T←**;

Press repeatedly **Fn**, **→T←**;

Press repeatedly **Fn**, **→T←**;

Press repeatedly **Fn**, **→T←**;

Press repeatedly **Fn**, **→T←**;

Press repeatedly **Fn**, **→T←**;

Press repeatedly **Fn**, **→T←**;

Press repeatedly **Fn**, **→T←**;



**→T←** (press and hold)



After selecting the "Setup" menu item a request to enter the access password "Code" will be shown on the display for 2 seconds.

The place for the first character of the password flashes.

- Enter password
  - Enter the numbers with the **Fn** key and save with the **→T←** key.
  - Press the **Fn** key (numbers in ascending order: 0-9) or the **→T←** key (numbers in descending order: 9-1) until the required character appears on the display.
  - If the password is longer than 7 characters the first character will be displaced to the right and out of the display.

The password set is shown on the display.

Confirm the password

Exit from the menu level

Save settings and exit menu

**General password:  
40414243**

**Service password:  
202122**





Minebea Intec Bovenden GmbH & Co. KG  
Leinetal 2  
37120 Bovenden, Germany

Phone: 49.551.309.83.0  
Fax: 49.551.309.83.190  
[www.minebea-intec.com](http://www.minebea-intec.com)

Copyright by Minebea Intec,  
Bovenden, Germany.

No part of this publication may be  
reprinted or translated in any form or  
by any means without prior written  
permission from Minebea Intec.

All rights reserved by Minebea Intec in  
accordance with copyright law.

The information and figures contained  
in these instructions correspond to the  
version date specified below. Minebea  
Intec reserves the right to make changes  
to the technology, features, specifications,  
and design of the equipment without  
notice.

Date: September 2017